

TOTAL[®]

Carbone One-Stop Tools Station

INDUSTRIAL

www.tecnoples.com.co

2023 - 2024



TOTAL

Compra en www.tecnoples.com.co

TOTAL



**HERRAMIENTAS
ELECTRICAS**

GENERADORES



**EQUIPOS DE
CONSTRUCCION**



TECNO PLES

MÁS QUE UN PROVEEDOR, SU MEJOR ALIADO

www.tecnoples.com.co

TOTAL

Compra en www.tecnoples.com.co

TOTAL

ACCESORIOS



HERRAMIENTAS MANUALES



PRODUCTOS DE SEGURIDAD



www.tecnoples.com.co



SHARE 150+



UNA BATERÍA PARA +150 HERRAMIENTAS

Taladro inalámbrico 3/8" de litio UTDLI20011

20V P20S

1.5Ah

INDUSTRIAL

3/8"

Voltaje: 20V
Velocidad sin carga: 0-400/0-1500 rpm
Control de torque: 15+1
Mandril: 3/8" sin llave
Máximo torque: 45NM
Velocidades: 2
Tiempo de carga: 2 hr
Indicador LED de energía de la batería
Luz integrada
Incluye 1 batería de litio, cargador, y accesorios

MODELO ECONÓMICO



SUPER SELECT

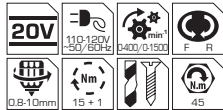

5

Taladro inalámbrico de impacto 3/8" de litio UTIDLI20012

20V P20S

Código antiguo UTDLI20012 Código nuevo UTIDLI20145

INDUSTRIAL

3/8"

Voltaje: 20V
Velocidad sin carga: 0-400/0-1500 rpm
Control de torque: 18 + 1 + 1
Mandril: 3/8" sin llave
Máximo torque: 45NM
Velocidad de impacto: 0-22500/min
Velocidades: 2
Tiempo de carga: 1 hr
Indicador LED de energía de la batería
Luz integrada
Incluye 2 baterías de litio, cargador, maletín y 50 accesorios



2.0Ah



FUNCIÓN DE IMPACTO

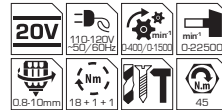

4

Taladro inalámbrico de impacto 1/2" de litio UTIDLI20031

20V P20S

INDUSTRIAL

1/2"

Voltaje: 20V
Velocidad sin carga: 0-450/0-1900 rpm
Control de torque: 23 + 1 + 1
Mandril: 1/2" sin llave
Máximo torque: 55NM
Velocidad de impacto: 0-22500/min
Velocidades: 2
Tiempo de carga: 1 hr
Indicador LED de energía de la batería
Luz integrada
Incluye 2 baterías de litio, cargador, maletín y 50 accesorios



2.0Ah



FUNCIÓN DE IMPACTO

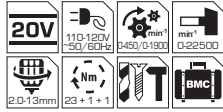

4

Taladro inalámbrico de impacto 3/8" de litio TIDLI201451

20V P20S

INDUSTRIAL

3/8"

NEW

Voltaje: 20V
Velocidad sin carga: 0-400/0-1500 rpm
Control de torque: 18 + 1 + 1
Mandril: 3/8" sin llave
Máximo torque: 45NM
Velocidad de impacto: 0-22500/min
Velocidades: 2
Tiempo de carga: 1 hr
Indicador LED de energía de la batería
Luz integrada
Incluye 1 broca para destornillador. Trae 3 brocas para mampostería.



NO incluye batería ni cargador



FUNCIÓN DE IMPACTO

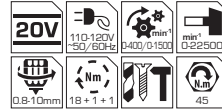

5

Taladro inalámbrico de impacto 1/2" de litio UTIDLI20608

1/2" 20V P20S

INDUSTRIAL

1/2"

2.0Ah

Voltaje: 20V
Velocidad sin carga: 0-450/0-1900 rpm
Control de torque: 23 + 1 + 1
Mandril: 1/2" sin llave
Máximo torque: 60NM
Velocidad de impacto: 0-22500/min
Velocidades: 2
Tiempo de carga: 1 hr
Indicador LED de energía de la batería
Luz integrada
Incluye 2 baterías de litio, cargador



NEW



FUNCIÓN DE IMPACTO

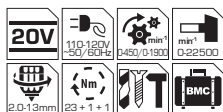

4

Taladro inalámbrico de impacto 1/2" de litio TIDLI206081

20V P20S

INDUSTRIAL

1/2"

NEW

Voltaje: 20V
Velocidad sin carga: 0-450/0-1900 rpm
Control de torque: 23 + 1 + 1
Mandril: 1/2" sin llave
Máximo torque: 60NM
Velocidad de impacto: 0-22500/min
Velocidades: 2
Tiempo de carga: 1 hr
Indicador LED de energía de la batería
Luz integrada
Incluye 47 piezas de accesorios



MOTOR SIN ESCOBILLAS NO incluye batería ni cargador



FUNCIÓN DE IMPACTO

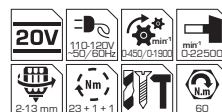

5

Taladro inalámbrico de impacto 3/8" de litio

UTDLI20028

3/8" 20V P20S 1.5Ah

INDUSTRIAL

SUPER SELECT



Voltaje: 20V
 Velocidad sin carga: 0-400/0-1500 rpm
 Control de torque: 15 + 1
 Mandril: 1/32"-3/8"
 Máximo torque: 45NM
 Velocidades: 2
 Tiempo de carga: 1 hr
 Indicador LED de energía de la batería
 Luz integrada
 Incluye 2 baterías de litio de 1.5h, cargador

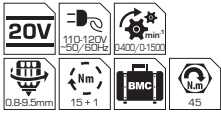

4

Llave de impacto dado cuadrado inalámbrico 1/2" de litio

UTIWLI2001

20V P20S 2.0Ah

INDUSTRIAL

Voltaje: 20V
 Motor sin escobillas
 Punta cuadrada: 1/2" (12.5mm)
 Velocidad sin carga: 0-2300/min
 Máx. torque: 300 N.m (221 lb.ft)
 Velocidad de impacto: 0-3550 bpm
 Tiempo de carga: 1 hr
 Indicador LED de energía de la batería
 Luz integrada
 Incluye 2 baterías de litio, cargador, maletín, 3 pzs de sockets (17 mm, 19 mm, 21 mm)



5

Llave de impacto dado cuadrado inalámbrico 1/2" de litio

TIWLI20010

20V P20S 2.0Ah

INDUSTRIAL

Voltaje: 20V
 Motor sin escobillas
 Punta cuadrada: 1/2" (12.5mm)
 Velocidad sin carga: 0-1600/min
 0-2400/min
 Máx. torque: 300 N.m (221 lb.ft)
 Velocidad de impacto: 0-2500/bpm
 0-3700/bpm
 Luz integrada
 Incluye 3 pzs de sockets (17 mm, 19 mm, 21 mm)



Incluye 3 pzs de sockets (17 mm, 19 mm, 21 mm)

NO incluye batería ni cargador



10

Llave de impacto dado hexagonal inalámbrico 1/4" de litio

UTIRLI2002

20V P20S 2.0Ah

INDUSTRIAL

Voltaje: 20V
 Motor sin escobillas
 Punta hexagonal: 1/4" (6.35mm)
 Velocidad sin carga: 0-2400/min
 Máx. torque: 200 N.m (147.5 lb.ft)
 Velocidad de impacto: 0-3550 bpm
 Tiempo de carga: 1 hr
 Indicador LED de energía de la batería
 Luz integrada
 Incluye 2 baterías de litio, cargador, maletín, 2 pzs de destornillador, 3pcs para fijar tuercas



5

Batería de litio

TFBLI20011

INDUSTRIAL

20V P20S 2.0Ah

UNA sola batería para múltiples herramientas



2.0Ah

Voltaje: 20V
 Indicador LED de energía de la batería

Innovado por TOTAL
 Patente No. ZL 2018 3 0305235.1

20

Batería de litio 4.0Ah

TFBLI2002

INDUSTRIAL

20V P20S 4.0Ah

UNA sola batería para múltiples herramientas



4.0Ah

Voltaje: 20V
 Indicador LED de energía de la batería

Innovado por TOTAL
 Patente No. ZL 2018 3 0305233.1

12

Batería de litio 5.0Ah

TFBLI2053

INDUSTRIAL

20V P20S

UNA sola batería para
múltiples herramientas



5.0Ah

Voltaje: 20V

Indicador LED de energía de la batería

BATERÍA INALÁMBRICA **7.5ah**
+ PODER
+ DURACIÓN

TFBLI2075

P20S

20V

NEW



7.5Ah

NUEVA

Cargador rápido para
batería de litio

UTFCLI2001

INDUSTRIAL

20V P20S



2000mA

Voltaje: 20V

Carga total en 1 hora

Voltaje: 110-240V-50/60Hz

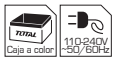

Innovado por TOTAL
Patente No: ZL 2018 3 0305233.1



Cargador rápido de 4A
para batería de litio

UTFCLI20411

INDUSTRIAL

20V P20S



4.0A

NEW

Voltaje: 20V

Carga batería 20V 2.0Ah en 0.5Hr

Carga batería 20V 4.0Ah en 1Hr

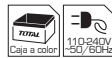

Cargador doble de 4A
para batería de litio

UTCLI2034

INDUSTRIAL

20V P20S



NEW

4.0A

Voltaje: 20V

Carga batería 20V 2.0Ah en 0.5Hr

Carga batería 20V 4.0Ah en 1Hr



Cargador USB - A
para batería de litio

TUCLI2022

20V P20S



Voltaje: 20V

Potencia de salida: 1. 5V/1A 2. 12V/0.5A 3. 12V/0.5A

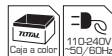

Código	Modelo
TUCLI2001	Antiguo
TUCLI2022	Mejorado

NO incluye batería ni
cargador

Combo inalámbrico

20V P20S

UTCKLI2010

INDUSTRIAL

NEW



Incluye:

Taladro: Velocidad sin carga 0-400/0-1500 rpm, máximo torque 45NM, 3/8"
Llave de impacto: Motor sin escobillas, 1/4", máximo torque 170NM
Caladora: Velocidad sin carga 2400 rpm, 5 hojas de corte
Sierra circular: Velocidad sin carga 3600 rpm, diámetro de hoja 140mm
 2 Baterías de 4Ah, Cargador y bolso



Combo inalámbrico

20V P20S

UTCKLI2048

INDUSTRIAL

SUPER SELECT

NEW



Incluye:

Taladro: Velocidad sin carga 0-400/0-1500 rpm, máximo torque 45NM, 3/8"
Lijadora: Motor sin escobillas, 3000/8500rpm, diámetro disco 4 1/2"
Linterna: LED 1.5W, Lumens 150±10%
 2 Baterías de 4Ah, Cargador, bolso y 10 discos



Combo inalámbrico

20V P20S

UTCKLI20418

INDUSTRIAL

SUPER SELECT

NEW



Incluye:

Taladro: Velocidad sin carga 0-400/0-1500 rpm, máximo torque 45NM, 3/8"
Lijadora: Motor sin escobillas, 3000/9000rpm, diámetro disco 4 1/2"
Linterna: LED 1.5W, Lumens 150±10%
 2 Baterías de 4Ah, Cargador, bolso y juego de discos



Combo inalámbrico

20V P20S

UTCKLI2017

INDUSTRIAL

SUPER SELECT

NEW



Incluye:

Taladro: Velocidad sin carga 0-400/0-1500 rpm, 1/32"-3/8"
Llave de impacto: Motor sin escobillas, 0-1300-2100rpm, 300NM
 2 Baterías de 4Ah, Cargador y bolso

2.0Ah



Rotomartillo inalámbrico de litio

20V P20S

TRHLI1601

INDUSTRIAL

Energía de impacto: 1.5J
 Velocidad sin carga: 0-900/min
 Tasa de impacto: 0-5100 bpm
 Perforación en concreto: 16mm
 Luz integrada
 Incluye 3 brocas SDS PLUS



Li-ion Battery

SDS PLUS

NO incluye batería ni cargador

2.0Ah



1.5J



Rotomartillo inalámbrico de litio, motor sin escobillas

20V P20S

TRHLI2201

INDUSTRIAL

Energía de impacto: 1.5J
 Velocidad sin carga: 0-1350/min
 Tasa de impacto: 0-4700 bpm
 Perforación en concreto: Ø22mm
 Luz integrada
 Incluye 3 brocas SDS PLUS



MOTOR SIN ESCOBILLAS

4.0Ah



1.5J

Li-ion Battery

NO incluye batería ni cargador



Rotomartillo SDS inalámbrico de litio, motor sin escobillas

TRHL20228 INDUSTRIAL

20V P20S



Energía de impacto: 2.0J
 Velocidad sin carga: 0-1100/min
 Tasa de impacto: 0-5000 bpm
 Perforación en concreto: Ø26mm
 Luz integrada
 Incluye 3 brocas y 1 cincel



MOTOR SIN ESCOBILLAS

4.0Ah



NO incluye batería ni cargador



Lijadora angular inalámbrica de litio

UTAGLI201158 INDUSTRIAL

20V P20S



Voltaje: 20V
 Velocidad sin carga: 8000/min
 Diámetro de disco: 4-1/2"
 Eje enroscado: 5/8"-11UNC

EJE ENROSCADO
5/8" 11UNC



SUPER SELECT



4.0Ah



MOTOR SIN ESCOBILLAS

NO incluye batería ni cargador



Lijadora angular inalámbrica de litio

UTAGLI2011582 INDUSTRIAL

20V P20S

MOTOR SIN ESCOBILLAS

Voltaje: 20V
 Velocidad sin carga: 8500/min
 Diámetro de disco: 4-1/2"
 Eje enroscado: 5/8"-11UNC
2 baterías 4Ah, cargador, bolso, Gratis 10 discos

EJE ENROSCADO
5/8" 11UNC



4.0Ah



115mm



MOTOR SIN ESCOBILLAS



Lijadora angular inalámbrica de litio

UTAGLI20157 INDUSTRIAL

20V P20S



Voltaje: 20V
 Velocidad sin carga: 3000/9000min
 Diámetro de disco: 4-1/2"
 Eje enroscado: 5/8"-11UNC

EJE ENROSCADO
5/8" 11UNC



4.0Ah



MOTOR SIN ESCOBILLAS

NO incluye batería ni cargador



Lijadora angular inalámbrica de litio

UTAGLI201572 INDUSTRIAL

20V P20S

SUPER SELECT

Voltaje: 20V
 Motor sin escobillas
 Velocidad sin carga: 3000/9000min
 Diámetro de disco: 4-1/2"
 Eje enroscado: 5/8"-11UNC

EJE ENROSCADO
5/8" 11UNC



Li-ion Battery

4.0Ah

115mm



MOTOR SIN ESCOBILLAS



Lijadora angular inalámbrica de litio

UTAGLI1151 INDUSTRIAL

20V P20S

Voltaje: 20V
 Velocidad sin carga: 8500/min
 Diámetro de disco: 4-1/2"
 Eje enroscado: 5/8"-11UNC

EJE ENROSCADO
5/8" 11UNC



4.0Ah



MOTOR SIN ESCOBILLAS

NO incluye batería ni cargador



Lijadora angular inálámbrica de litio
UTAGL1152 INDUSTRIAL

20V P20S

Voltaje: 20V
Motor sin escobillas
Velocidad sin carga: 9000/min
Diámetro de disco: 4-1/2"
Eje enroscado: 5/8"-11UNC

EJE ENROSCADO
5/8" 11UNC



Li-ion Battery

4.0Ah



MOTOR SIN ESCOBILLAS

NO incluye batería ni cargador

6

Herramienta múltiple inálámbrica de litio
TMLI2001 INDUSTRIAL

20V P20S



Li-ion Battery

2.0Ah

Voltaje: 20V
Velocidad sin carga: 5000-20000/min



NO incluye batería ni cargador

8

Sierra Caladora inálámbrica de litio
TJSLI6508 INDUSTRIAL

20V P20S

Velocidad sin carga: 2400/min
Capacidad de corte:
Madera: 2 1/2" (65mm)
Metal: 5/16" (8mm)
Incluye 1 hoja de corte

SUPER SELECT



NEW

Li-ion Battery

2.0Ah

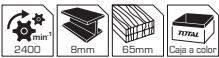

NO incluye batería ni cargador

5

Sierra Caladora inálámbrica de litio
TJSLI8501 INDUSTRIAL

20V P20S

Velocidad sin carga: 2600/min
Capacidad de corte:
Madera: 3 1/8" (80mm)
Metal: 5/16" (8mm)
Incluye 5 hojas de corte

Li-ion Battery

2.0Ah

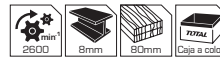

NO incluye batería ni cargador

5

Sierra recíproca inálámbrica de litio
TRSLI1152 INDUSTRIAL

20V P20S

Velocidad sin carga: 0-2800/min
Capacidad de corte:
Metal: 8mm
Madera: 115mm
Incluye 2 hojas de corte

SUPER SELECT

NEW



2.0Ah

Li-ion Battery

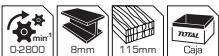

NO incluye batería ni cargador

4

Sierra recíproca inálámbrica de litio
TRSLI1151 INDUSTRIAL

20V P20S

Velocidad sin carga: 0-2800/min
Capacidad de corte:
Metal: 8mm
Madera: 115mm
Incluye 2 hojas de corte

Li-ion Battery

2.0Ah

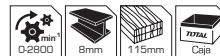

NO incluye batería ni cargador

4

Sierra circular inalámbrica de litio

TSLI1401

INDUSTRIAL

20V P20S

Velocidad sin carga: 3600/min
 Diámetro de hoja: 140 mm
 Capacidad de corte:

45 grado: 1 - 1/8" (28,5mm)
 90 grado: 1 - 9/16" (39mm)



4.0Ah



NO incluye batería ni cargador



Sierra circular inalámbrica de litio

TSLI1651

INDUSTRIAL

20V P20S

Velocidad sin carga: 4600/min
 Diámetro de hoja: 165 mm
 Capacidad de corte:

45 grado: 1 - 1/2" (38mm)
 90 grado: 2 - 5/32" (55mm)

Profundidad de corte ajustable
 Corte de bisel ajustable
 Incluye 1 hoja de corte de 165 mm



4.0Ah

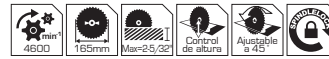

NO incluye batería ni cargador



Tijera para podar o cortar ramas inalámbrica de litio

UTSSLI203083

INDUSTRIAL

20V P20S

Motor sin escobilla
 Diámetro de corte: 20 mm/30 mm
 Incluye 1 batería, 1 cargador

NEW



2.0Ah



MOTOR SIN ESCOBILLAS



Tijera para podar o cortar ramas inalámbrica de litio

TSSLI2001

INDUSTRIAL

20V P20S

Motor sin escobilla
 Diámetro de corte: 20 mm/30 mm



2.0Ah



MOTOR SIN ESCOBILLAS

NO incluye batería ni cargador

Tijera para podar o cortar ramas inalámbrica de litio

UTSSLI202581

INDUSTRIAL

20V P20S

Motor sin escobilla
 Diámetro de corte: 25 mm
 Incluye 1 batería, 1 cargador

NEW



2.0Ah



MOTOR SIN ESCOBILLAS



Sierra ingletadora inalámbrica de litio

TMS2001

INDUSTRIAL

20V P20S

Velocidad sin carga: 3000/min
 Diámetro de hoja:
 210 mm (8-1/4")x25.4mm
 Capacidad de corte:

0° x 0°: 120 x 60 mm
 45° x 0°: 83 x 60 mm
 0° x 45°: 120 x 34 mm
 45° x 45°: 83 x 34 mm



NO incluye batería ni cargador



2.0Ah

Motosierra inalámbrica de litio, motor sin escobillas

UTGSLI201286 INDUSTRIAL

20V P20S

NEW

Voltaje: 20V
Motor sin escobillas
Potencia: 900 W
Velocidad de cadena: 3700-4500 rpm
Tamaño de hoja: 12"
Incluye 2 baterías 4.0Ah y un cargador



MOTOR SIN ESCOBILLAS

4.0Ah

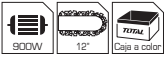

Li-ion Battery

2

Mini motosierra inalámbrica de litio, motor sin escobillas

UTGSLI20851 INDUSTRIAL

20V P20S

NEW

Voltaje: 20V
Motor sin escobillas
Velocidad de la cadena: 7.5m / s
Tamaño de hoja: 8"
Incluye 1 baterías 2.0Ah y un cargador



SUPER SELECT

MOTOR SIN ESCOBILLAS

2.0Ah



Li-ion Battery

2

Motosierra inalámbrica de litio, motor sin escobillas

TGSLI2001 INDUSTRIAL

20V P20S

4.0Ah

MOTOR SIN ESCOBILLAS

Li-ion Battery



NO incluye batería ni cargador

Voltaje: 20V
Motor sin escobillas
Potencia: 720 W
Velocidad de cadena: 7.7m/s
Tamaño de hoja: 12"



Repuesto barra Oregon
Cód: TGTSB51202 / TGTSB51201
(se vende por separado)

Repuesto cadena Oregon
Cód: TGTSC2001 / TGTSC51202
(se vende por separado)



Li-ion Battery

2

Mini motosierra inalámbrica de litio

TGSLI2068 INDUSTRIAL

20V P20S

NEW



Li-ion Battery

2.0Ah



MOTOR SIN ESCOBILLAS

NO incluye batería ni cargador

2

Podadora de extensión con motosierra inalámbrica de litio

UTPTS201681 INDUSTRIAL

20V P20S

SUPER SELECT **2.0Ah**

0-60cm

NEW



Voltaje: 20V
Tamaño de hoja: 8"
Velocidad de Cadena: 4.8 m/s
Incluye 1 Batería de 2.0 Ah y 1 Cargador.



Li-ion Battery

2

Cortasetos podadora de extensión inalámbrica de litio

UTPHT2016012 INDUSTRIAL

20V P20S

NEW

2.0Ah

0-60cm



Voltaje: 20V
Longitud de hoja: 520mm
Velocidad: 2800rpm
Incluye 1 Batería de 2.0 Ah y 1 Cargador.



Li-ion Battery

2

Cortadora de setos inalámbrica de litio
TSTLI2001 INDUSTRIAL

20V P20S



Voltaje: 20V
Velocidad sin carga: 1200/min
Tamaño de hoja: 200mm
Distancia entre dientes: 8 mm

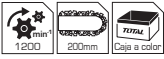

Li-ion Battery
2.0Ah

NO incluye batería ni cargador

8

Cortadora de setos inalámbrica de litio
THTLI20018 INDUSTRIAL

20V P20S



Voltaje: 20V
Velocidad sin carga: 1400/min
Tamaño de hoja: 18"
Distancia entre dientes: 18 mm

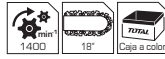

Li-ion Battery
2.0Ah

NO incluye batería ni cargador

2

Cortadora de setos inalámbrica de litio
UTHTLI20461 INDUSTRIAL

20V P20S

NEW
DOUBLE BLADE MOVING
2.0Ah



Voltaje: 20V
Velocidad sin carga: 1400/min
Tamaño de hoja: 18"
Batería, cargador, guantes, lentes



Li-ion Battery
2.0Ah

NO incluye batería ni cargador

2

Desmalezadora (Wira) inalámbrica
UTGTLI20301 INDUSTRIAL

20V P20S

NEW
180°
2.0Ah



Velocidad sin carga: 8200/min
Diámetro de línea: 1.6mm
Diámetro de corte: 300mm
Largo total de línea: 5m
Batería, cargador, guantes, lentes



Li-ion Battery
2.0Ah

NO incluye batería ni cargador

2

Desmalezadora (Wira) inalámbrica
TGTLI20328 INDUSTRIAL

20V P20S

NEW
Velocidad sin carga: 8200/min
Diámetro de línea: 1.6mm
Diámetro de corte: 300mm
Largo total de línea: 5m



Li-ion Battery
2.0Ah

NO incluye batería ni cargador

2

Desmalezadora (Wira) inalámbrica
TGTLI2001 INDUSTRIAL

20V P20S

Velocidad sin carga: 7800/min
Diámetro de línea: 1.6mm
Diámetro de corte: 300mm
Largo total de línea: 5m



Li-ion Battery
2.0Ah

NO incluye batería ni cargador

2

Desmalezadora (Wira) inalámbrica
TGTLI20018 INDUSTRIAL

20V P20S

Velocidad sin carga: 8200/min
Diámetro de línea: 1.6mm
Diámetro de corte: 300mm
Largo total de línea: 5m



Li-ion Battery
2.0Ah

NO incluye batería ni cargador



2

Desmalezadora (Wira) inalámbrica
TSTLI20018 INDUSTRIAL

20V P20S

Voltaje: 40V
Motor sin escobillas
Velocidad sin carga: 0-5500/min 0-7500/min
Diámetro de corte de cuchilla: 255mm
Diámetro de corte: 330mm
Diámetro de línea: 2mm
Largo total de línea: 5m

MOTOR SIN ESCOBILLAS

Li-ion Battery
2.0Ah

NO incluye batería ni cargador



1

Cortagrama inalámbrica de litio
TLMLI2014 INDUSTRIAL

20V P20S

NEW

14"

Voltaje: 40V
Velocidad sin carga: 3800/min
Diámetro máximo de corte: 340mm
Volumen: 30L
Rango de altura de corte: 20 - 70mm
Engranaje de corte: 6ª marcha



Li-ion Battery
2.0Ah



NO incluye batería ni cargador

Cortagrama inalámbrica de litio
TLMLI20182 INDUSTRIAL

20V P20S

NEW

18"

5.0Ah

Voltaje: 40V
Velocidad sin carga: 2500-3000rpm
Diámetro máximo de corte: 510mm
Volumen: 60L
Rango de altura de corte: 30 - 80mm
Opciones de altura de corte: 8 posiciones

MOTOR SIN ESCOBILLAS



Metal Chassis 30-80mm



NO incluye batería ni cargador

Vibrador de concreto inalámbrica de litio
TCVLI202301 INDUSTRIAL

20V P20S

NEW

Voltaje: 20V
Velocidad sin carga: 2300/min
Especificaciones de botón: Ø35x120mm



Li-ion Battery
2.0Ah

NO incluye batería ni cargador



6

Vibrador de concreto inalámbrica de litio
UTCVLI2023013 INDUSTRIAL

20V P20S

NEW

Voltaje: 20V
Velocidad sin carga: 2300/min
Especificaciones de botón: Ø35x120mm
2 baterías 2Ah, cargador, bolso



Li-ion Battery
2.0Ah



NO incluye batería ni cargador

6

Cortador de cable hidráulico inalámbrico de litio UTCLI2002 INDUSTRIAL

20V P20S



16-400mm²

Max. diámetro de corte: 42mm
Fuerza de prensado: 120 KN
Rango de prensado: 16-400mm²
Pantalla LED de conteo de uso
Trazo: 42 mm
Incluye 2 baterías de 4.0 Ah, un cargador y maletín



1

Cortador de cable hidráulico inalámbrico de litio UTRCLI2002 INDUSTRIAL

20V P20S



Ø 85 mm

Max. diámetro de corte: 85mm
Fuerza de prensado: 60 KN
Pantalla LED de conteo de uso
Trazo: 86 mm
Incluye 2 baterías de 4.0 Ah, un cargador y maletín

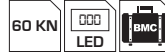

6

Lijadora orbital aleatoria inalámbrico de litio TROSLI2001 INDUSTRIAL

20V P20S

Voltaje: 20V
Velocidad sin carga: 10000/min
Tamaño de hoja: 5" (125 mm)
Incluye 5 lijas



x5pzaz



NO incluye batería ni cargador

4

Lijadora orbital delta inalámbrico de litio TDSLII2051 INDUSTRIAL

20V P20S

Voltaje: 20V
Velocidad sin carga: 13000/min
Tamaño de hoja: 5" (125 mm)
Incluye 3 lijas



x3pzaz

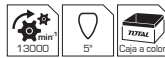

NO incluye batería ni cargador

8

Pulidora inalámbrico de litio, motor sin escobillas TAPLI2002 INDUSTRIAL

20V P20S

Voltaje: 20V
Velocidad sin carga: 2000 - 4800/min
Tamaño de hoja: 5" (125 mm)



Pantalla LCD que muestra la velocidad



MOTOR SIN ESCOBILLAS

NO incluye batería ni cargador

6

Pulidora inalámbrico de litio, motor sin escobillas TAPLI2001 INDUSTRIAL

Voltaje: 20V
Velocidad sin carga: 500 - 2800/min
Tamaño de hoja: 6" (150 mm)
Pantalla LCD que muestra la velocidad



MOTOR SIN ESCOBILLAS

NO incluye batería ni cargador

6

Hidrolavadora inalámbrica de litio UTPWLI20084

INDUSTRIAL

20V P20S

Presión: 25 Bar (362 psi)
Flujo max.: 2.2L/min
Incluye pistola de 5 tipos de pulverizado
Manguera de 6m para entrada de agua
Cañón de foam de jabón o shampo incluido para limpieza de vehículos
Bolsa portátil
Sistema de parada automático

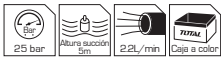

Li-ion Battery 4.0Ah

1

Hidrolavadora inalámbrica de litio TPWLI2008

INDUSTRIAL

20V P20S

Presión: 24.8 Bar (362 psi)
Flujo max.: 2.2L/min
Incluye pistola de 6 tipos de pulverizado
Manguera de 6m para entrada de agua
Envase de 400ml para espuma
Conector de autosucción
Bolsa portátil
Sistema de parada automático

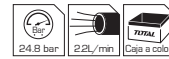

NO incluye batería ni cargador Li-ion Battery 4.0Ah

2

Hidrolavadora inalámbrica de litio UTPWLI20282

INDUSTRIAL

20V P20S

Presión: 24.5 Bar
Flujo max.: 2.5L/min
Manguera de 3m para entrada de agua
Envase de 100ml para espuma
Pistola pulverizadora de 2 patrones
Incluye 1 batería de 2.0Ah
1 cargador rápido



2 pattern

Li-ion Battery 2.0Ah

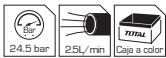

6

Pistola de aire para pintar inalámbrica de litio TSGLI2001

INDUSTRIAL

20V P20S

NO necesita compresor
Presión: 0.1 - 0.2 Bar
Flujo de aire: 600 ml/min
Viscosidad máxima de la pintura: 40 DIN-s
Capacidad del envase: 800 ml
Incluye aguja de mantenimiento



Li-ion Battery 2.0Ah



NO incluye batería ni cargador

8

Rociador pulverizador inalámbrico de litio TSPLI2001

INDUSTRIAL

20V P20S

Capacidad: 16 L
Presión: 5 Bar
Flujo: 1.45 L/min
Distancia del rociador: 5m.
Gatillo en forma de T.

16L



Li-ion Battery 2.0Ah

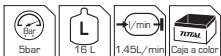

NO incluye batería ni cargador

8

Compresor de aire inalámbrico de litio TACLI2003

Impulsado por 2 baterías de 20V
Volumen del tanque: 6L
Presión max.: 135 PSI
Tasa de flujo: 98L/min



Li-ion Battery 4.0Ah

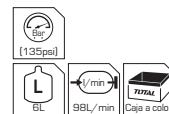

NO incluye batería ni cargador

1

Mini compresor inflador de llantas inalámbrico

TACLI2001 INDUSTRIAL

20V P20S

Presión máxima: 150 PSI/ 10 Bar
Incluye 1 adaptador para balón
Incluye 1 adaptador para llanta



2.0Ah

NO incluye batería ni cargador



4

Soplador - Aspiradora inalámbrica de Litio

TABLI2001 INDUSTRIAL

20V P20S

Velocidad sin carga: 10000-12500-17000/min
Volumen de aire máximo: 2.7m³/min
Incluye bolsa de polvo



2.0Ah

NO incluye batería ni cargador

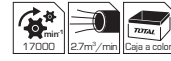

4

Soplador y Aspirador inalámbrica de Litio

TABLI2003 INDUSTRIAL

20V P20S

Velocidad sin carga: 6000-11500/min
Volumen de aire máximo: 600m³/h
Velocidad del aire: 190km/h



2.0Ah

NO incluye batería ni cargador

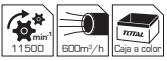

1

Soplador inalámbrica de Litio

UTABLI203235 INDUSTRIAL

20V P20S

Velocidad sin carga: 15000/min
Volumen de aire promedio: 8.5m³/min
Velocidad del aire: 32m/seg



SUPER SELECT



2.0Ah

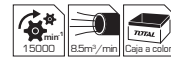

1

Soplador - Aspiradora inalámbrica de Litio

TABLI20428 INDUSTRIAL

20V P20S

Velocidad sin carga: 15000/min
Volumen de aire máximo: 8.5m³/min
Velocidad del aire: 42m/seg



2.0Ah

NO incluye batería ni cargador

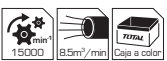

MOTOR SIN ESCOBILLAS

2

Soplador inalámbrica de Litio

TABLI20018 INDUSTRIAL

20V P20S

Velocidad sin carga: 18000/min
Volumen de aire máximo: 2.7m³/min



2.0Ah

NO incluye batería ni cargador

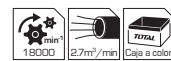

4

Aspiradora inalámbrica de litio

TVLI2001

INDUSTRIAL

20V P20S

Voltaje: 20V
Capacidad: 0.7L
Vacuidad: ≥ 7.0 Kpa
Peso: 1.1 kg



Li-ion Battery
2.0Ah

NO incluye batería ni cargador



4

Aspiradora inalámbrica

TVLI2006

INDUSTRIAL

20V P20S

Voltaje: 20V
Potencia: 120W
Ciclón múltiple
Capacidad: 0.8L
Batería de litio 2.0 Ah
Presión de vacío: ≥ 9 Kpa
Tiempo de trabajo:
35 min - nivel de velocidad baja
18 min - nivel de velocidad alta



2.0Ah

Li-ion Battery



1

Aspiradora inalámbrica de litio

TVLI2005E

INDUSTRIAL

20V P20S

Voltaje: 20V
Capacidad: 20L
Vacuidad: ≥ 8.0 Kpa
Diámetro de la manguera: 32 mm
Largo de manguera: 1.5 m



Li-ion Battery
2.0Ah

NO incluye batería ni cargador

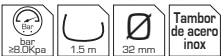

1

Compresor de aire inalámbrico de litio

TACL2002

INDUSTRIAL

20V P20S

Voltaje: 20V
Presión: 160PSI (11Bar)
Pantalla digital
Luz LED



Li-ion Battery
2.0Ah

Encendido por vehículo o por batería de litio 20V



NO incluye batería ni cargador

4

Clavadora inalámbrica de litio

TCBNLI2028

INDUSTRIAL

20V P20S

Voltaje: 20V
Tipo de clavo: F15 - F50
Velocidad de operación: 2.5nails/s
Capacidad: 100pcs
Tiempo de aceleración: 80ms



Li-ion Battery
2.0Ah

NO incluye batería ni cargador



4

Clavadora inalámbrica de litio

UTCBNLI3508

INDUSTRIAL

20V P20S

Voltaje: 20V
Tipo de clavo: F15 - F35
Velocidad de operación: 3 nails/s
Capacidad: 105pcs
Incluye batería 20V 2.0Ah y cargador



Li-ion Battery
2.0Ah X1

Li-ion Battery
2.0Ah



6

Lámpara de trabajo inalámbrica de litio **20V**
TWLI2023 INDUSTRIAL **P20S**

NEW

150 Lumens

90°

Li-ion Battery **2.0Ah**

Lumens: 150
Led: 1.5W

NO incluye batería ni cargador

12

Ventilador inalámbrico de litio **20V**
TFALI2007 INDUSTRIAL **P20S**

Voltaje: 20V
Tamaño: 7"

Li-ion Battery **2.0Ah**

NO incluye batería ni cargador

Angulo ajustable 7"

1

Ventilador inalámbrico de litio **20V**
UTFALI2001 INDUSTRIAL **P20S**

Voltaje: 20V
Velocidades: 3
Tamaño: 13"

Indicador temporizador: 1H/2H/4H

Li-ion Battery **2.0Ah**

NO incluye batería ni cargador

3 velocidades Angulo ajustable 13"

1

Radio bluetooth inalámbrico de litio **20V**
TJRLI2001 INDUSTRIAL **P20S**

Bluetooth

Li-ion Battery **2.0Ah**

Voltaje: 20V
Frecuencia AM: 522-1620 KHz
Frecuencia FM: 87.5-108 MHz
Jack auxiliar: 3.5 mm
Salida de altavoz: 3 W
Bluetooth: 4.0
Puerto USB

NO incluye batería ni cargador

8

Soldador inalámbrico de litio **20V**
TSILI2001 INDUSTRIAL **P20S**

Voltaje: 20V
Potencia: 40 W
Tiempo de calentamiento: 3 - 5 minutos

Li-ion Battery **2.0Ah**

NO incluye batería ni cargador

40W 3-5 min

20

Pistola de pegamento inalámbrica de litio **20V**
TGGLI2001 INDUSTRIAL **P20S**

Voltaje: 20V
Capacidad de encolado: 13-18g/min
Diámetro de la barra de pegamento: 11.2mm
Tiempo de calentamiento: 60 seg.

Li-ion Battery **2.0Ah**

NO incluye batería ni cargador

13-18g/min 60 seg 11.2 mm

36

Mezcladora inalámbrica de litio **20V**
TMXLI2001 INDUSTRIAL **P20S**

EJE ENROSCADO M14

Li-ion Battery **2.0Ah**

Voltaje: 20V
Velocidad sin carga: 0 - 650/min
Eje enroscado: M14

NO incluye batería ni cargador

0-650 min⁻¹ M14 Caja a color

4

Calafateadora inalámbrica de litio **20V**
TCGLI2001 INDUSTRIAL **P20S**

NEW

Voltaje: 20V
Empuje: 2000N
Velocidad de pegado 0.5mm/s - 4.4mm/s
Sin corriente de carga: 0.35A

Li-ion Battery **2.0Ah**

MOTOR SIN ESCOILLAS

NO incluye batería ni cargador

Caja a color

6

Lámpara de trabajo inalámbrica de litio **20V**
TWLI2025 INDUSTRIAL **P20S**

NEW

Lumens: en alta: 1800
en baja: 900
Led: 20W

Li-ion Battery **2.0Ah**

NO incluye batería ni cargador

1800LM 900LM LED 20W

6

Taladro inalámbrico de litio 3/8"

UTDLI1211 INDUSTRIAL

Velocidad sin carga: 0-600/min
Control de torque: 15+1
Mandril: 3/8" sin llave
Máximo torque: 20NM
Tiempo de carga: 2 hrs
Incluye 1 batería de litio, cargador



Batería de Litio

12V



Código	V	Compatible
TBLI12151	12	UTDLI1211

Cargador

12V



Código	V	Compatible
UTCLI12071	12	UTDLI12325

Taladro inalámbrico de litio 3/8"

UTDLI12325 INDUSTRIAL

Velocidad sin carga: 0-350/0-1350 min
Control de torque: 15+1
Mandril: 3/8" sin llave
Máximo torque: 20NM
Tiempo de carga: 2 hrs
Incluye 2 baterías de litio, cargador y maletín

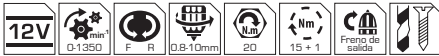

Innovado por TOTAL
Patente No: ZL 2016 3 0238603.5

Batería de Litio

12V



Código	V	Compatible
TBLI12152	12	UTDLI12325

Cargador

12V



Código	V	Compatible
UTCLI12071	12	UTDLI12325

Taladro inalámbrico de litio 3/8"

UTDLI12415 INDUSTRIAL

Velocidad sin carga: 0-600/ min
Control de torque: 15+1
Mandril: 1/32" - 3/8" sin llave
Máximo torque: 20NM
Tiempo de carga: 2 hrs
Incluye 1 batería de litio 1.5Ah, cargador y 1 punta Cr-V 65mm



Taladro de impacto inalámbrico de litio 3/8"

UTIDL1232 INDUSTRIAL

Velocidad sin carga: 0-400/0-1500 min
Control de torque: 18+1+1
Mandril: 3/8" sin llave
Máximo torque: 20NM
Tiempo de carga: 2 hrs
Velocidad de impacto: 0-22500/min
Incluye 2 baterías de litio, cargador y maletín



12V
1.5Ah



Código antiguo: UTIDL1232
Código nuevo: UTDLI12201

Kit de herramientas inalámbrico de litio

UTKLI1203 INDUSTRIAL

Incluye taladro, llave de impacto 1/4", interna, 2 baterías, 1 cargador y una maleta

1.5Ah



Llave de impacto inalámbrico de litio 1/4"

UTIRLI1201 INDUSTRIAL

Motor sin escobillas
Velocidad sin carga: 0-2000 / min
Punta hexagonal: 1/4"
Máximo torque: 100NM
Tiempo de carga: 1 hrs
Velocidad de impacto: 0-2800 BPM
Incluye 2 baterías de litio, cargador y maletín



Conjunto de herramientas de 81 piezas

UTHKTHP10812 INDUSTRIAL

- 1 Taladro inalámbrico de 12V 1.5 Ah
- 1 batería de 12V
- 1 cargador
- 1 adaptador magnético para puntas
- 1 Destornillador SL5.5x100
- 1 Destornillador PH1x100
- 1 alicata de combinación de 7"
- 1 llave ajustable de 6"
- 1 mini martillo de oreja de 8oz.
- 1 Lápiz de prueba (Voltaje de prueba: 100-500VAC)
- 1 Cinta métrica de acero 3mt.
- 1 cuchilla de corte 9mm
- 4 brocas para albañilería 4.5,6,8, mm
- 5 brocas helicoidales 2,3,4,5,6 mm
- 20 puntas de destornillador
- 20 tornillos (10 pzas *ST3.5, 10 pzas *ST4)
- 20 tapones de plástico (10 pzas *6mm, 10 pzas *5mm)

12V
1.5Ah



Conjunto de herramientas de 127 piezas

UTHKTHP1272 INDUSTRIAL

- 1 Taladro inalámbrico de 12V 1.5 Ah
- 1 batería de 12V
- 1 cargador
- 1 adaptador de dados 4 - 6mm
- 1 Destornillador SL5.5x100
- 1 Destornillador PH1x100
- 1 alicata de combinación de 7"
- 1 llave ajustable de 6"
- 1 martillo de oreja de 8oz.
- 1 Lápiz de prueba (100-500VAC)
- 1 Cinta métrica de acero 3mt
- 1 Adhesiva Aislante
- 1 cuchilla de corte
- 4 brocas para albañilería 4,5,6,8, mm
- 5 brocas helicoidales 2,3,4,5,6 mm
- 20 puntas de destornillador
- 40 tornillos (20 pzas *ST3.5, 10 pzas *ST4, 10 pzas *ST5)
- 40 tapones de plástico (20 pzas *5mm, 10 pzas *6mm, 10 pzas *8mm)
- Socket hexagonal 1/4", 5/16", 11/32", 3/8", 7/16", 1/2"

12V
1.5Ah



Destornillador inalámbrico de litio

TSDLI0402

INDUSTRIAL

Velocidad sin carga: 180/min
Vástago hexagonal: 1/4"
Máximo torque: 4NM
Indicador de nivel de carga
Luz integrada

4V



SUPER SELECT



20

Destornillador inalámbrico de litio

TSDLI0403

INDUSTRIAL

Velocidad sin carga: 240/min
Vástago hexagonal: 1/4"
Máximo torque: 4NM
Indicador de nivel de carga
Luz integrada

4V



20

Taladro de impacto 1/2"

UTG1061356

INDUSTRIAL

Voltaje: 110-120V-50/60Hz
Potencia: 680W
Velocidad sin carga: 0-3000/min
Velocidad de impacto: 0-48000/min
Mandril: 1/16" - 1/2"

680W

SUPER SELECT



10

Taladro eléctrico 3/8"

UTD2051026

INDUSTRIAL

Voltaje: 110-120V-50/60Hz
Potencia: 500W
Velocidad sin carga: 0-3300/min
Velocidad variable
Mandril: 1/16" - 3/8"

500W

10mm

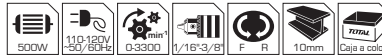

5

Innovado por TOTAL
Patente No: ZL 2015 3 0180748.X

Taladro eléctrico 3/8"

UTD502106

INDUSTRIAL

Voltaje: 110-120V-50/60Hz
Potencia: 280W
Velocidad sin carga: 0-750/min
Velocidad variable
Control de torque: 20+1
Mandril: 1/32" - 3/8"

280W

10mm

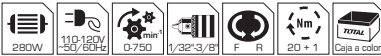

10

Taladro de impacto 1/2"

UTG108136

INDUSTRIAL

Voltaje: 110-120V-50/60Hz
Potencia: 750W
Velocidad sin carga: 0-3000/min
Velocidad de impacto: 0-48000/min
Mandril: 1.5-13mm

750W



5

Innovado por TOTAL
Patente No: ZL 2016 3 0047949.7

Taladro de impacto 1/2"

UTG1081316

INDUSTRIAL

Voltaje: 110-120V-50/60Hz
Potencia: 810W
Velocidad sin carga: 0-2800/min
Mandril: 1/2"

810W



5

Taladro de impacto 1/2"

UTG109136

INDUSTRIAL

Voltaje: 110-120V-50/60Hz
Potencia: 850W
Velocidad sin carga: 0-2400/min
Velocidad de impacto: 0-43200/min
Mandril: 1/2"

850W



5

Innovado por TOTAL
Patente No: ZL 2011 3 0496421.5

Taladro de impacto 1/2"

UTG111136

INDUSTRIAL

Voltaje: 110-120V-50/60Hz
Potencia: 1010W
Velocidad sin carga: 0-2800/min
Velocidad de impacto: 0-44800/min
Mandril: 1/2"

1010W



5

Taladro de impacto 5/8"

UTG111165

INDUSTRIAL

Voltaje: 110-120V-50/60Hz
Potencia: 1050W
Velocidad sin carga: 0-1100/0-3000/min
Velocidad de impacto: 0-17600/0-48000/min
Mandril: 5/8"

1050W



5

Innovado por TOTAL
Patente No: ZL 2015 3 0446512.6

Llave de impacto

UTIW10101

INDUSTRIAL

1050W

Voltaje: 110-120V-50/60Hz
Potencia: 1050W
Velocidad sin carga: 2300/min
Máx. torque: 550 Nm
Caja de engranajes en aluminio
Trae 6 dados de impacto sockets (17,18,19,21,23,24mm) y adaptadores



2

Conjunto de herramientas de 115 piezas

UTHKTHP1152

INDUSTRIAL

680W

SUPER SELECT

- 1 Taladro de impacto 550W (110-120V-50/60Hz, llave 13mm)
- 1 Martillo de orejas 80z
- 1 Alcате de combinación 7"
- 1 Llave ajustable 6"
- 1 Destornillador SL5.5x100
- 1 Destornillador PH1x100
- 1 Cinta métrica de acero 3mt
- 4 Brocas de madera 4,5,6,8mm
- 1 Cuchilla de presión
- 1 Lápiz de prueba
- 1 Cinta de aislamiento de pvc
- 5 Brocas helicoidales 2,3,4,5,6mm
- 5 Brocas de albañilería 4,5,6,8,10mm
- 10 Puntas de destornillador PH1, PH2, PZ1, PZ2, SL4, SL6, HEX 4, HEX 5, T20, T25
- 1 Soporte de brocas magnéticas
- 40 tornillos (20 pzas *ST3.5, 10 pzas *ST4, 10 pzas *ST5)
- 40 Tapones de plástico (20 pzas *5mm, 10 pzas *6mm, 10 pzas *8mm)



4

Rotomartillo

UTH308268

INDUSTRIAL

800W

SDS PLUS

Voltaje: 110-120V-50/60Hz
Potencia: 800W
Energía de impacto: 2.5J
Velocidad sin carga: 0-1200/min
Tasa de impacto: 5300/min
Perforación en concreto: 26mm
Incluye 3 brocas, 2 cinceles y maletín



4

Rotomartillo

SDS PLUS

UTH308268-2

INDUSTRIAL

800W

Voltaje: 110-120V-50/60Hz
Potencia: 800W
Energía de impacto: 2.5J
Velocidad sin carga: 0-1100/min
Tasa de impacto: 4000/min
Perforación en concreto: 26mm
acero: 13mm - madera: 30mm
Incluye 3 brocas, 2 cinceles y maletín



4

Rotomartillo

UTH110286

INDUSTRIAL

1050W

SDS PLUS

Voltaje: 110-120V-50/60Hz
Potencia: 1050W
Energía de impacto: 5J
Velocidad sin carga: 900/min
Tasa de impacto: 4000/min
Perforación en concreto: 28mm
Perforación en acero: 13mm y madera: 40mm
Incluye 3 brocas, 2 cinceles y maletín

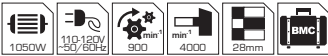

2

Rotomartillo

UTH110266

INDUSTRIAL

1050W

SDS PLUS

Voltaje: 110-120V-50/60Hz
Potencia: 1050W
Energía de impacto: 4.5J
Velocidad sin carga: 1100/min
Tasa de impacto: 3800/min
Perforación en concreto: 1"



2

Rotomartillo

UTH2130016

INDUSTRIAL

1300W

SDS HEX

Voltaje: 110-120V-50/60Hz
Potencia: 1300W
Energía de impacto: 20J
Tasa de impacto: 3800/min
Sistema antivibración.
Sistema de mandriles HEX
Incluye 2 cinceles, 1 set de escobillas y maletín



1

Rotomartillo

UTH1153226

INDUSTRIAL

1500W

SDS PLUS

Voltaje: 110-120V-50/60Hz
Potencia: 1500W
Energía de impacto: 5.5J
Velocidad sin carga: 850/min
Tasa de impacto: 4400/min
Perforación en concreto: 32mm
Incluye 3 brocas, 2 cinceles y maletín



2

Rotomartillo

UTH215002

INDUSTRIAL

SDS MAX

1500W

Voltaje: 110-120V-50/60Hz
Potencia: 1500W
Energía de impacto: 6 - 25J
Tasa de impacto: 1000 - 1900 bmp
Sistema anti-vibración
Sistema de mandril SDS-MAX
Rompedora de demolición de 10 Kg



1

Rotomartillo

UTH1153256

INDUSTRIAL

1500W

SDS PLUS

Voltaje: 110-120V-50/60Hz
Potencia: 1500W
Energía de impacto: 5.5J
Velocidad sin carga: 950/min
Tasa de impacto: 4500/min
Perforación en concreto: 1 1/4"
Perforación en acero: 1/2" y madera: 1 1/2"
Sistema antivibración
Incluye 3 brocas, 2 cinceles y maletín



2

Demoledora

UTH215456

INDUSTRIAL

1700W

Voltaje: 110-120V-50/60Hz
Potencia: 1700W
Energía de impacto: 50J
Tasa de impacto: 1900/min
Incluye maletín y 2 cinceles hex

SDS HEX



Innovado por TOTAL
Patente No: ZL 2015 3 0212663.5



Demoledora

UTH220502

INDUSTRIAL

2200W

Voltaje: 110-120V-50/60Hz
Potencia: 2200W
Energía de impacto: 75J
Tasa de impacto: 950/min
Incluye maletín y 2 cinceles hex

TH220502-S
Sostenedor
para demoledora
(Se vende por separado)

SDS HEX



Lijadora angular

UTG10711556

INDUSTRIAL

750W

Voltaje: 110-120V-50/60Hz
Potencia: 750W
Velocidad sin carga: 12000/min
Diámetro de disco: 4 1/2"
Eje enroscado: 5/8 - 11UNC

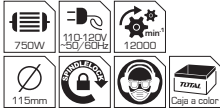

**SUPER
SELECT**



Lijadora angular

UTG10912556

INDUSTRIAL

900W

Voltaje: 110-120V-50/60Hz
Potencia: 900W
Velocidad sin carga: 12000/min
Diámetro de disco: 5"
Eje enroscado: 5/8 - 11UNC

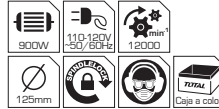

Lijadora angular

UTG109125565

INDUSTRIAL

900W

Voltaje: 110-120V-50/60Hz
Potencia: 900W
Velocidad sin carga: 5000-11000/min
Diámetro de disco: 5"
Eje enroscado: 5/8 - 11UNC



Velocidad
variable



Lijadora angular

UTG1091156, UTG1101256

INDUSTRIAL

950W

Voltaje: 110-120V-50/60Hz
Potencia: 950W
Velocidad sin carga: 11000/min
Diámetro de disco: 4 1/2", 5"
Eje enroscado: 5/8 - 11UNC

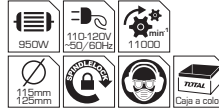

Lijadora angular

UTG11512526

INDUSTRIAL

1500W

Voltaje: 110-120V-50/60Hz
Potencia: 1500W
Velocidad sin carga: 11000/min
Diámetro de disco: 5"
Eje enroscado: 5/8 - 11UNC



Lijadora angular

UTG12018026

INDUSTRIAL

2000W

Voltaje: 110-120V-50/60Hz
Potencia: 2000W
Velocidad sin carga: 8450/min
Diámetro de disco: 7"
Eje enroscado: 5/8 - 11UNC



Lijadora angular

UTG12223026

INDUSTRIAL

2200W

Voltaje: 110-120V-50/60Hz
Potencia: 2200W
Velocidad sin carga: 6600/min
Diámetro de disco: 9"
Eje enroscado: 5/8 - 11UNC



Lijadora angular

UTG1252306

INDUSTRIAL

2400W

Voltaje: 110-120V-50/60Hz
Potencia: 2400W
Velocidad sin carga: 8500, 6300/min
Diámetro de disco: 9"
Eje enroscado: 5/8 - 11UNC



Pulidora de felpa

1400W

UTP1141806 INDUSTRIAL

Voltaje: 110-120V-50/60Hz
Potencia: 1400W
Velocidad sin carga: 900-3800/min
Diámetro de disco: 180mm
Incluye 1 felpa y 1 plato



Innovado por TOTAL
Patente No: ZL 2016 3 0195792.2

4

Pulidora de felpa

1400W

UTP11418018 INDUSTRIAL

Voltaje: 110-120V-50/60Hz
Potencia: 1400W
Velocidad sin carga: 1500-3600/min
Diámetro de disco: 7"



Innovado por TOTAL
Patente No: ZL 2016 3 0462392.3

4

Sierra caladora

UTS206656 INDUSTRIAL

Voltaje: 110-120V-50/60Hz
Potencia: 570W
Velocidad sin carga: 800-3000/min
Base de aluminio
Capacidad de corte:
Madera: 2 1/2" (65mm)
Acero: 5/16" (8mm)

570W

SUPER
SELECT



3pzas de
cuchillas

5

Sierra caladora

UTS2081006 INDUSTRIAL

Voltaje: 110-120V-50/60Hz
Potencia: 800W
Velocidad sin carga: 800-3000/min
Base de aluminio
Capacidad de corte:
Madera: 4 3/8" (100mm)
Acero: 3/8" (10mm)

800W



Innovado por TOTAL
Patente No: ZL 2016 3 0462392.3

6

Sierra recíproca

750W

UTS100806 INDUSTRIAL

Voltaje: 110-120V-50/60Hz
Potencia: 750W
Velocidad sin carga: 900-3300/min
Incluye 1 cuchilla para madera y metal
Capacidad de corte:
Madera: 4 1/2" (115mm)
Acero: 5/16" (8mm)
Aluminio: 1/2" (12mm)



Innovado por TOTAL
Patente No: ZL 2017 3 0684236.6

2

Sierra circular

1400W

UTS11418526 INDUSTRIAL

Voltaje: 110-120V-50/60Hz
Potencia: 1400W
Velocidad sin carga: 4800/min
Capacidad de corte: 90°=65mm/45°=44mm
Diámetro de disco: 185mm



Innovado por TOTAL
Patente No: ZL 2017 3 0684236.6

2

Sierra circular

1400W

UTS1141856 INDUSTRIAL

Voltaje: 110-120V-50/60Hz
Potencia: 1400W
Velocidad sin carga: 4800/min
Capacidad de corte: 90°=65mm/45°=44mm
Diámetro de disco: 185mm
Carcaza y mango de goma



Innovado por TOTAL
Patente No: ZL 2016 3 0253674.2

2

Cortadora de mármol

1400W

UTS3141102 INDUSTRIAL

Voltaje: 110-120V-50/60Hz
Potencia: 1400W
Velocidad sin carga: 13000/min
Profundidad de corte: 1 3/8"



Innovado por TOTAL
Patente No: ZL 2017 3 0059373.0

4

Acanaladora de pared

1500W

UTWLC1256 INDUSTRIAL

Voltaje: 110-120V-50/60Hz
Potencia: 1500W
Velocidad sin carga: 9000/min
Profundidad de corte: 3 - 29mm
Ancho de corte: 8 - 30mm
Eje enroscado: 5/8 - 11UNC
Diámetro de disco: 5" (127mm)



Innovado por TOTAL
Patente No: ZL 2017 3 0059373.0

2

Lijadora de palma

240W

UTF2231106 INDUSTRIAL

Voltaje: 110-120V-50/60Hz
Potencia: 240W
Velocidad sin carga: 14000/min
Base: 4 3/8"x4"



Innovado por TOTAL
Patente No: ZL 2017 3 0059373.0

10

Lijadora **INDUSTRIAL** **NEW** **240W**

UTF1302206

Voltaje: 110-120V-50/60Hz
Potencia: 240W
Velocidad sin carga: 14000/min
Base: 110x100mm

240W 110-120V-50/60Hz 14000min⁻¹ x5 110x100mm Caja a color

x5pzas

Lijadora **INDUSTRIAL** **320W**

UTF1301826

Voltaje: 110-120V-50/60Hz
Potencia: 320W
Velocidad sin carga: 14000/min
Base: 185x93mm

320W 110-120V-50/60Hz 14000min⁻¹ x5 185x93mm Caja a color

x5pzas

Lijadora orbital **INDUSTRIAL** **320W**

UTF2031256

Voltaje: 110-120V-50/60Hz
Potencia: 320W
Velocidad sin carga: 12000/min
Diámetro de almohadilla: 125mm (5")

320W 110-120V-50/60Hz 12000min⁻¹ 125mm Caja a color

x5pzas

Router **INDUSTRIAL** **500W**

UTLT5001

Voltaje: 110-120V-50/60Hz
Potencia: 500W
Velocidad sin carga: 33500/min
Diámetro de puntas: 1/4" (6mm)

500W 33500min⁻¹ 1/4" Color box

Mini Router **INDUSTRIAL** **600W**

UTLT6001

Voltaje: 110-120V-50/60Hz
Potencia: 600W
Velocidad sin carga: 34500/min
Diámetro de puntas: 1/4" (6mm)

600W 34500min⁻¹ 1/4" Color box

NEW

Router **INDUSTRIAL** **1600W**

UTR111216

Voltaje: 110-120V-50/60Hz
Potencia: 1600W
Velocidad sin carga: 22000/min
Capacidad de perforado: 0-60mm
Diámetro de puntas: 1/4", 1/2"

1600W 22000min⁻¹ 1/4"-1/2" Capacidad perforación 0-60mm Color box

Router **INDUSTRIAL** **2200W**

UTR111226

Voltaje: 110-120V-50/60Hz
Potencia: 2200W
Velocidad sin carga: 9000-23000/min
Capacidad de perforado: 0-60mm
Diámetro de puntas: 1/4", 1/2"
Velocidad variable

2200W 9000-23000min⁻¹ 1/4"-1/2" Capacidad perforación 0-60mm Color box

Router **INDUSTRIAL** **2200W**

UTR11122

Voltaje: 110-120V-50/60Hz
Potencia: 2200W
Velocidad sin carga: 9000-23000/min
Capacidad de perforado: 0-60mm
Diámetro de puntas: 1/4", 1/2"

2200W 9000-23000min⁻¹ 1/4"-1/2" Capacidad perforación 0-60mm Color box

Mezclador de pintura, pasta **INDUSTRIAL** **NEW** **1400W**

UTD614006

Voltaje: 110-120V-50/60Hz
Potencia: 1400W
Velocidad sin carga: 180-480rpm/300-750rpm
Rosca: 5/8 - 11UNC

1400W 110-120V-50/60Hz 750rpm Color box

Cepillo eléctrico **INDUSTRIAL** **1050W**

UTL1108236

Voltaje: 110-120V-50/60Hz
Potencia: 1050W
Velocidad sin carga: 16000/min
Medida de cepillado: 82x3mm

1050W 110-120V-50/60Hz 16000min⁻¹ 82mm 0-3mm Color box

Innovado por TOTAL
Patente No: ZL 2017 3 0321976.3

Mini mototool

UTG501032

INDUSTRIAL

Código antiguo Código nuevo
UTG501032 UTG513326

130W

Voltaje: 110-120V-50/60Hz
Potencia: 130W
Velocidad sin carga: 10000-32000/min
Tamaño de cuello: 3.2mm
Velocidad variable
Incluye accesorios



5

Pistola de pegamento

UTT101116

INDUSTRIAL

Voltaje: 110-120V-50/60Hz
Potencia: 20W(100W)
Capacidad de encolado: 13-18g/min
Diámetro de la barra: 11.2mm



Repuesto
Barras de pegamento

TACGT2061

2pzas de
pegamento



36

Innovado por TOTAL
Patente No: ZL 2017 3 0059140.0

Pistola de pegamento

UTT301116

INDUSTRIAL

Repuesto
6 barras de pegamento

Voltaje: 110-120V-50/60Hz
Potencia: 30W(220W)
Capacidad de encolado: 20-30g/min
Diámetro de la barra: 11.2mm



TACGT2061

8pzas de
pegamento

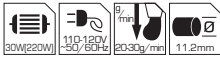

24

Pistola de calor

UTB20036

INDUSTRIAL

2000W

Voltaje: 110-120V-50/60Hz
Potencia: 2000W
Temperatura: 350°C/550°C
Flujo: 300/500 L/min
Incluye 4 boquillas y un raspador de metal

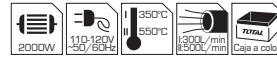

10

Innovado por TOTAL
Patente No: ZL 2015 3 0519640.9

Pistola rociadora

UTT3506

INDUSTRIAL

350W

Voltaje: 110-120V-50/60Hz
Presión: 0.1 - 0.2 Bar
Flujo de aire: 380 ml/min
Viscosidad máxima de la pintura: 50 DIN-s
Capacidad del envase: 800 ml
Diámetro de boquilla: 2.5 mm
Incluye aguja de mantenimiento, copa de medida



8

Innovado por TOTAL
Patente No: ZL 2017 3 0521156.2

Pistola rociadora

UTT5006

INDUSTRIAL

500W

Voltaje: 110-120V-50/60Hz
Presión: 0.1 - 0.2 Bar
Flujo de aire: 380 ml/min
Viscosidad máxima de la pintura: 50 DIN-s
Capacidad del envase: 800 ml
Diámetro de boquilla: 2.5 mm
Incluye aguja de mantenimiento, copa de medida



Innovado por TOTAL
Patente No: ZL 2017 3 0767209.6

Sopladora

UTB2046

INDUSTRIAL

400W

Voltaje: 110-120V-50/60Hz
Potencia: 400W
Velocidad sin carga: 14000/min
Velocidad máx. de soplado: 3.0m³/min
Incluye bolsa de polvo



4

Innovado por TOTAL
Patente No: ZL 2015 3 0242388.1



Esmeril de banco

UTBG15015 INDUSTRIAL

150W

Voltaje: 110-120V-50/60Hz
Potencia: 150W
Velocidad sin carga: 3450/min
Tamaño de rueda: 150mm (6")
Base de aluminio heavy duty



Esmeril de banco

UTBG35020 INDUSTRIAL

350W

Voltaje: 110-120V-50/60Hz
Potencia: 350W
Velocidad sin carga: 3450/min
Tamaño de rueda: 200mm (8")
Base de aluminio heavy duty



Ingletadora

UTS42142101 INDUSTRIAL

1400W

Voltaje: 110-120V-50/60Hz
Potencia: 1400W
Velocidad sin carga: 5000/min
Diámetro de disco: 210mm (8")
Capacidad de corte: 55x120mm
Cortes de 0-45° de derecha a izquierda
Incluye un disco de sierra

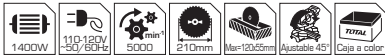

Ingletadora

UTS42182552 INDUSTRIAL

1800W

Voltaje: 110-120V-50/60Hz
Potencia: 1800W
Velocidad sin carga: 5500/min
Diámetro de disco: 255mm (10")
Capacidad de corte: 140x70mm
Cortes de 0-45° de derecha a izquierda
Incluye un disco de sierra

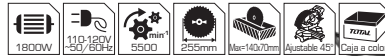

Sierra ingleteadora 8"

UTS42142107 INDUSTRIAL

1400W

Voltaje: 110-120V-50/60Hz
Potencia: 1400W
Velocidad sin carga: 5000/min
Capacidad de corte: 2-3/16"x4-3/4"
Diámetro de disco: 8-1/4"x1"

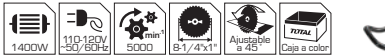

Sierra ingleteadora 10"

UTS42152557 INDUSTRIAL

1800W

Voltaje: 110-120V-50/60Hz
Potencia: 1800W
Velocidad sin carga: 5500/min
Capacidad de corte: Inglete/Bisel: Ancho x Alto
0°/0°: 5-1/2"x2-48/64"
45°/0°: 3-3/4"x2-48/64"
0°/45°: 5-1/2"x1-3/8"
45°/45°: 3-3/4"x1-3/8"
Diámetro de disco: 10"x1-12/64"

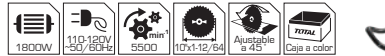

Ingletadora

UTS42182551 INDUSTRIAL

1800W

Voltaje: 110-120V-50/60Hz
Potencia: 1800W
Velocidad sin carga: 5500/min
Diámetro de disco: 255mm (10")
Capacidad de corte: 80x280mm
Barra doble para deslizamiento suave
Cortes de 0-45° de derecha a izquierda
Incluye un disco de sierra

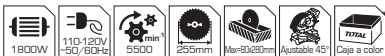

Sierra caladora

UTS88501 INDUSTRIAL

85W

Voltaje: 110-120V-50/60Hz
Potencia: 85W
Velocidad sin carga: 1450/min
Profundidad máxima de corte: 50mm
Ancho máximo de corte: 410mm
Tamaño de la mesa: 375x250mm
Rango de inclinación de la mesa: 0-45°
Tamaño de hoja: 133*2.6*0.25mm(18TPI)

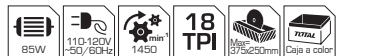

Taladro de banco

UTDP133501 INDUSTRIAL

350W

Voltaje: 110-120V-50/60Hz
Potencia: 350W
Velocidad sin carga: 760-3070/min
Velocidades: 5
Altura: 590mm
Mandril: 1/2"
Peso: 19kg



Taladro de banco

UTDP207502 INDUSTRIAL

750W

Voltaje: 110-120V-50/60Hz
Potencia: 750W
Velocidad sin carga: 200-2600/min
Velocidades: 16
Altura: 1600mm
Mandril: 3/4"
Peso: 67kg



Sierra de mesa

UTS5152542 INDUSTRIAL

Voltaje: 110-120V-50/60Hz
Potencia: 1500W
Tamaño de disco: 255mm (10")
Velocidad sin carga: 4500/min
Capacidad de corte: 90°=80mm/45°=55mm
Tamaño de mesa: 725x490mm
Extensión derecha izquierda: 440 x 125mm

1500W

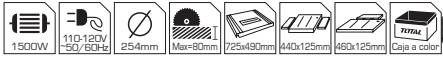

1

Tronzadora

UTS92035526 INDUSTRIAL

Voltaje: 110-120V-50/60Hz
Potencia: 2350W
Velocidad sin carga: 3800/min
Tamaño de hoja: 355x25.4x3mm

2350W

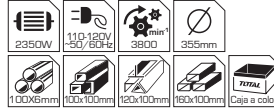

1

Máquina de soldar electrodos MMA inverter

UTW21606 INDUSTRIAL

Voltaje	110 - 220
Frecuencia (Hz)	50 - 60
Fase	Monofásica
Amperaje	10 - 160A
Ciclo de trabajo(%)	160A@40%
Voltaje sin carga	75V
Tamaño electrodo	1.6 - 4.0 mm



Incluye:
• Pinza de soldar
• Pinza de tierra
• Cepillo
• Careta

4

Máquina de soldar electrodos MMA inverter

UTW21605 INDUSTRIAL

Voltaje	110 - 220
Frecuencia (Hz)	50 - 60
Fase	Monofásica
Amperaje	10 - 160A
Ciclo de trabajo(%)	160A@60%
Voltaje sin carga	85V
Tamaño electrodo	1.6 - 4.0 mm



Incluye:
• Pinza de soldar
• Pinza de tierra
• Cepillo
• Careta

2 1

Máquina de soldar electrodos MMA inverter

UTW21301 INDUSTRIAL

Voltaje	110 - 220
Frecuencia (Hz)	50 - 60
Fase	Monofásica
Amperaje	10 - 130A
Ciclo de trabajo(%)	130A@30%
Voltaje sin carga	75V
Tamaño electrodo	1.6 - 3.2 mm



Incluye:
• Pinza de soldar
• Pinza de tierra
• Cepillo
• Careta

4

Máquina de soldar electrodos MMA inverter

UTW22005 INDUSTRIAL

Voltaje	110 - 220
Frecuencia (Hz)	50 - 60
Fase	Monofásica
Amperaje	15 - 200A
Ciclo de trabajo(%)	200A@60%
Voltaje sin carga	85V
Tamaño electrodo	1.6 - 5.0 mm



Incluye:
• Pinza de soldar
• Pinza de tierra
• Cepillo
• Careta

2

Máquina de soldar inverter MIG - MMA - MMA - TIG

UTMGT1601 INDUSTRIAL

Voltaje	110 - 220
Frecuencia (Hz)	50 - 60
MAG / MIG (Amp)	30-160
MMA (Amp)	10 - 160
TIG (Amp)	10 - 160
Ciclo de trabajo(%)	30%@40°C
Voltaje sin carga	80V
Tamaño de alambre	0.6,0.8,1.0mm
Velocidad del cable (m/min)	2 - 11
Diámetro del electrodo	1.6 - 4.0mm

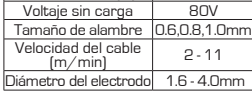

Incluye:
• Pinza de soldar
• Pinza de tierra
• Cepillo y careta
• 1 pza MIG Antorcha
• Cable de extensión y enchufe

1

Pinza de electrodos

TWAH3006 INDUSTRIAL

300A

Corriente: 300A
Heavy duty



Cobre

Cobre



40

Pinza de electrodos

TWAH5006 INDUSTRIAL

500A

Corriente: 500A
Heavy duty



Cobre



30

Pinza de electrodos

TWAH8006 INDUSTRIAL

800A

Corriente: 800A
Heavy duty



Cobre

Cobre



30

Juego de soporte de soldadura magnética 6 pzas
TAMWH6002 INDUSTRIAL



x4



x2

Código	Tamaño	Capacidad	Ángulo
TAMWH6002	mini (4 pzas) 3" (2 pzas)	10 lbs 25 lbs	45°,90°,135°



Soporte de soldadura magnética
TAMWH25032 INDUSTRIAL



25lbs

Código	Tamaño	Capacidad	Ángulo
TAMWH25032	3"	25 lbs	45°,90°,135°



Soporte de soldadura magnética
TAMWH50046 INDUSTRIAL



50lbs

Código	Tamaño	Capacidad	Ángulo
TAMWH50046	4"	50 lbs	30°,45°,75°,105°,120°,135°



Soporte de soldadura magnética
TAMWH50042, TAMWH75052 INDUSTRIAL



Código	Tamaño	Capacidad	Ángulo	Caja grande	Caja chica
TAMWH50042	4"	50 lbs	45°,90°,135°	30	5
TAMWH75052	5"	75 lbs	45°,90°,135°	18	3

Soporte de soldadura magnética
TAMWH4001 INDUSTRIAL



10lbs



Código	Pzas	Capacidad	Ángulo
TAMWH4001	4	10 lbs	45°,90°,135°



Soporte de soldadura magnética
TAMWH7006 INDUSTRIAL



10 - 25lbs



Código	Pzas	Capacidad	Ángulo
TAMWH7006	7	10 - 25lbs	45°,90°,135°



Bomba de agua a gasolina

TP3101 (1")

INDUSTRIAL

1"

Motor de gasolina de 2.5 HP OHV TOTAL
Depósito de combustible de metal con filtro
Impulsor y voluta de hierro fundido
Carcasa fundida a presión
Encendido a cuerda

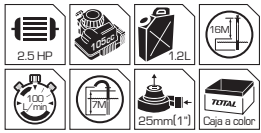

Bomba de agua a gasolina

INDUSTRIAL

TP3202 (2"), TP3302 (3")

Motor de gasolina de 7.0 HP OHV TOTAL
Depósito de combustible de metal con filtro
Entramado tubular completo
Impulsor y voluta de hierro fundido
Carcasa fundida a presión
Encendido a cuerda

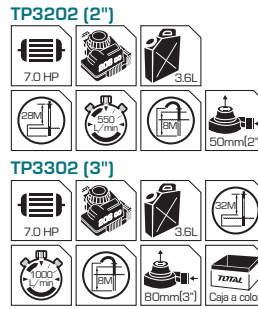

Bomba de agua a gasolina

TP3201H

INDUSTRIAL

2"

NEW

Diámetro del puerto de succión: 50mm, 2"
Diámetro del puerto de descarga: 50mm, 2"/40mm, 1.5"/40mm, 1.5"
Max.flujo: 300L/min
Max.subida: 75/80m
Max.succión cabeza: 7m
Motor de gasolina de 7.5HP
Cilindrada: 212cc
Tanque de combustible: 3.6L
Sistema de inicio: Retroceso

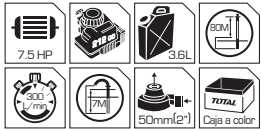

Motor a gasolina 6.5HP

TGEN1682

INDUSTRIAL

6.5HP

NEW

Max.output: 6.5HP
Diámetro del árbol de levas: 20 mm, tipo S
Max.torque: 12.4Nm
Tipo de motor: 4 tiempos, OHV
Desplazamiento (ml): 196
BorexStroke: 68X54mm
Sistema de enfriamiento: refrigerado por aire
Sistema de encendido: T.C.I
Sistema de inicio: Retroceso
Tanque de combustible (L): 3.6L
Capacidad de aceite: 0.6L
Consumo de combustible: 290g / HP.hr
Función de alerta de aceite



Motor a gasolina 6.5HP

TGEN16821

INDUSTRIAL

6.5HP

NEW

Max.output: 6.5HP
Diámetro del árbol de levas: 19 mm, tipo Q
Max.torque: 12.4Nm
Tipo de motor: 4 tiempos, OHV
Desplazamiento (ml): 196
BorexStroke: 68X54mm
Sistema de enfriamiento: refrigerado por aire
Sistema de encendido: T.C.I
Sistema de inicio: Retroceso
Tanque de combustible (L): 3.6L
Capacidad de aceite: 0.6L
Consumo de combustible: 290g / HP.hr
Función de alerta de aceite



Motor a gasolina 13HP

TGEN1881

INDUSTRIAL

13HP

NEW

Max.output: 13.OHP
Diámetro del árbol de levas: 25.4mm tipo Q
Max.torque: 29Nm
Tipo de motor: 4 tiempos, OHV
Desplazamiento (ml): 389
BorexStroke: 88X64mm
Sistema de enfriamiento: refrigerado por aire
Sistema de encendido: T.C.I
Sistema de inicio: Retroceso
Tanque de combustible (L): 6.0L
Capacidad de aceite: 1.1L
Consumo de combustible: 280g / HP.hr
Función de alerta de aceite



Bomba de agua diesel

TP5401 (4")

INDUSTRIAL

Motor diesel de 8.3 HP OHV TOTAL
 Depósito de combustible de metal con filtro
 Entramado tubular completo
 Impulsor y voluta de hierro fundido
 Carcasa fundida a presión
 Encendido a cuerda



4"

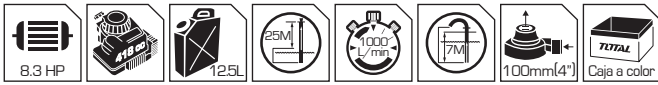

Código	Modelo
TP5402	Antiguo
TP5401	Mejorado



Generador diesel y soldador

UTP446001

INDUSTRIAL

SOLDADOR DIESEL

4600W

Voltaje: 110 - 220V~50/60Hz
 Interruptor automático AC
 Fase: Monofásico
 Sistema AVR: proporciona un control de voltaje preciso
 Motor diesel de 9.0 HP TOTAL
 Corriente: 50 - 180A
 Batería libre de mantenimiento
 60% ciclo de trabajo para soldadura continúa

INDUSTRIAL

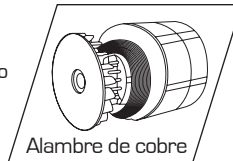

Generador diesel (monofásico)

UTP450001

INDUSTRIAL

5500W

Voltaje: 110 - 220V~50/60Hz
 Panel de control completo fácil de usar
 Interruptor automático AC
 Sistema AVR: proporciona un control de voltaje preciso
 Motor diesel de 9.0 HP TOTAL
 Sistema de enfriamiento
 Batería libre de mantenimiento
 Encendido eléctrico

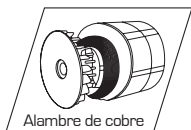

Generador a gasolina

UTP18001

INDUSTRIAL

800W

Voltaje: 110 - 120V~50/60Hz
 Capacidad nominal: 0.65Kw / Max 0.8Kw
 Panel de control completo fácil de usar
 Interruptor automático AC
 Sistema de enfriamiento por aire
 Motor a gasolina de 2.0 HP TOTAL

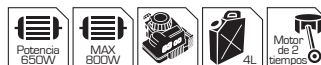
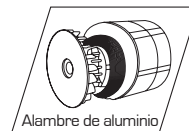

Generador inversor a gasolina

UTP530001 INDUSTRIAL



2200W

Voltaje: 110 - 120V~50/60Hz
Frecuencia nominal: 60Hz
Max. output: 2.2kV
Salida nominal: 2.0kW
Potencia estable a menos del 3% THD
Nivel de ruido de carga de 50% ≤ 54dB
Sistema de encendido: C.D.I
Velocidad: 4800 rpm
Motor: Monocilindrico, 4 tiempos, OHV

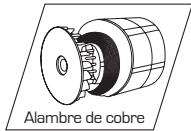

Generador a gasolina

UTP115001 INDUSTRIAL

1200W

Voltaje: 110 - 220V~50/60Hz
Panel de control completo fácil de usar
Motor de gasolina de 2.5 HP OHV TOTAL
Sistema AVR: proporciona un control de voltaje preciso
Gran depósito de combustible de metal con filtro
Interruptor automático AC
Sistema de enfriamiento
Encendido por cuerda

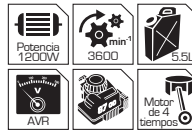
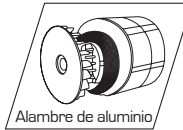

Generador a gasolina

UTP130005 INDUSTRIAL

3000W

Voltaje: 110 - 220V~50/60Hz
Panel de control completo fácil de usar
Motor de gasolina de 7.0 HP OHV TOTAL
Sistema AVR: proporciona un control de voltaje preciso
Gran depósito de combustible de metal con filtro
Interruptor automático AC
Sistema de enfriamiento
Encendido por cuerda

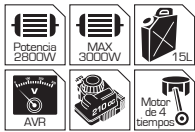
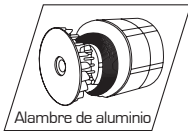

Generador a gasolina

UTP155001 INDUSTRIAL

6500W

Voltaje: 110 - 220V~50/60Hz
Panel de control completo fácil de usar
Interruptor automático AC
Sistema AVR: proporciona un control de voltaje preciso
Gran depósito de combustible de metal con filtro
Motor de gasolina de 13 HP OHV TOTAL
Sistema de enfriamiento
Encendido por cuerda

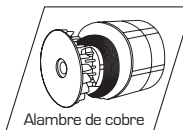

Generador a gasolina

UTP180006 INDUSTRIAL

8000W

Voltaje: 110 - 220V~50/60Hz
Panel de control completo fácil de usar
Interruptor automático AC
Sistema AVR: proporciona un control de voltaje preciso
Gran depósito de combustible de metal con filtro
Motor de gasolina de 15.0 HP OHV TOTAL
Sistema de enfriamiento
Encendido por cuerda

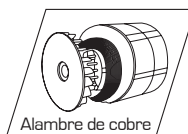

Generador diesel silencioso

UTP250001

INDUSTRIAL

Voltaje: 110 - 220V~50/60Hz
 Capacidad nominal: 5.0Kw /Max 5.5Kw
 Fase: Monofásico
 Panel de control completo fácil de usar
 Sistema AVR: proporciona un control de voltaje preciso
 Motor diesel de 9.0 HP TOTAL
 Sistema de enfriamiento por aire
 Encendido eléctrico
 Batería libre de mantenimiento

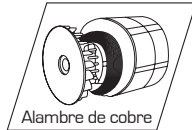

5000W



Generador diesel silencioso

UTP2150K1

INDUSTRIAL

Voltaje: 110 - 220V~50/60Hz
 Capacidad nominal: 15Kw /Max 20Kw
 Fase: Monofásico
 Velocidad: 1500 rpm
 Alternador: sin escobillas
 Motor de 4 tiempos / 4 cilindros
 Desplazamiento: 2.15
 Enfriado por agua
 Encendido eléctrico
 Protección contra falta de agua, aumento de temperatura, nivel de aceite
 Peso: 840kg

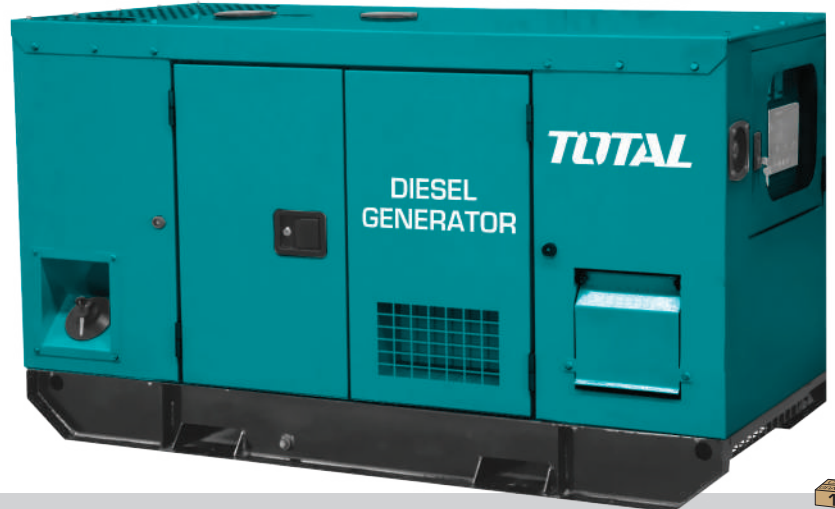
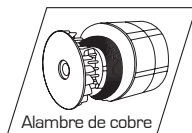

15Kw



Generador diesel silencioso

UTP2300K1-1

INDUSTRIAL



Tensión nominal (V): 110-120/220-240
 Frecuencia nominal (Hz): 60
 Fase: Individual
 Max.output (kW): 33.0
 Salida nominal (kW): 30.0
 Con función ATS
 Velocidad nominal (rpm): 1800
 Motor: Diesel, 4 cilindros
 Desplazamiento (L): 3.875
 Tanque de combustible: 50L
 Alternador: sin escobillas
 Alternador de bobina de cobre
 Sistema de arranque: Eléctrico
 Sistema de refrigeración: Agua
 Sistema de control: LCD SmartGen
 Peso seco (Kg): 990

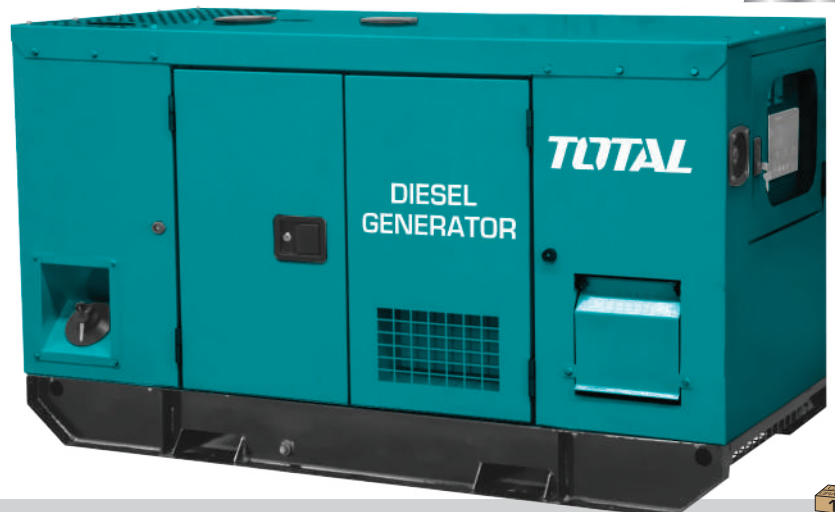
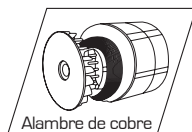

33Kw



Protector de voltaje AC

TPVS40153

INDUSTRIAL

1.5kVA

Dos transformadores 100% de alambre de cobre puro en el interior.
 Voltaje: 110 - 250V
 Capacidad nominal: 1.5kVA
 Protección al sobrevoltaje: $>246V \pm 4V$
 Indicación de bajo voltaje
 Pantalla analógica
 Con 5 segundos de retraso
 Protección de fusibles



Protector de voltaje AC

TPVS40503

INDUSTRIAL

5kVA

Dos transformadores 100% de alambre de cobre puro en el interior.
 Voltaje: 110 - 250V
 Capacidad nominal: 5kVA
 Protección al sobrevoltaje: $>246V \pm 4V$
 Protección de bajo voltaje: $<184V \pm 4V$
 Con bypass y selector de retardo
 Peso neto: 25kg



Protector de voltaje AC

TPVS42003

INDUSTRIAL

20kVA

Dos transformadores 100% de alambre de cobre puro en el interior.
 Voltaje: 110 - 250V
 Capacidad nominal: 20kVA
 Protección al sobrevoltaje: $>246V \pm 4V$
 Protección de bajo voltaje: $<184V \pm 4V$
 Con bypass y selector de retardo
 Peso neto: 64kg



Protector de voltaje AC

TPVS43003

INDUSTRIAL

30kVA

Dos transformadores 100% de alambre de cobre puro en el interior.
 Voltaje: 120 - 250V
 Capacidad nominal: 30kVA
 Protección al sobrevoltaje: $>246V \pm 4V$
 Protección de bajo voltaje: $<184V \pm 4V$
 Con bypass y selector de retardo
 Peso neto: 124kg

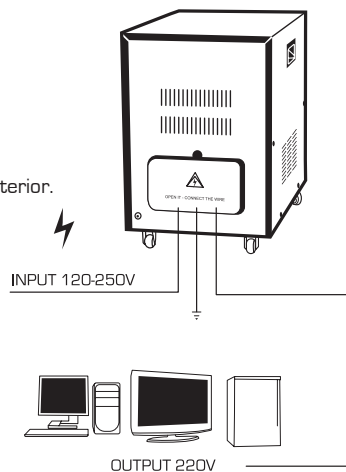

Apisonadora compactadora a gasolina

TP880-1

INDUSTRIAL

5.5HP

Motor
HONDA
GX160

Potencia
4.0 Kw

kg
79 2.0L

Motor: Honda GX160
Potencia: 4.0Kw [5.5HP]
Fuerza de impacto: 10kN
Altura de salto: 65mm
Tasa de impacto: 450-660 rpm
Tanque: 2.0L
Medida de zapato: 33x29cm
Peso: 79Kg

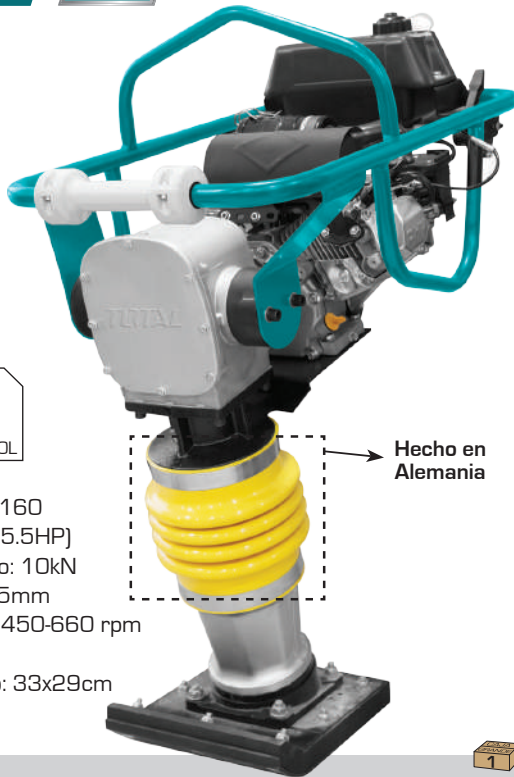

Hecho en Alemania



Cortadora de pavimento a gasolina

TP1016-1

INDUSTRIAL

13HP

- Marco de la caja super rígido, asegura recortes rectos.
- Agarraderas cómodas con altura ajustable.
- Manivela de fácil uso para subir y bajar la profundidad de corte.
- El tanque de agua proporciona un flujo óptimo de agua a la cuchilla.



Motor
HONDA
GX390

Potencia
9.6 Kw

kg
120

2.8L

Motor: Honda GX390
Potencia: 9.6Kw [13HP]
Máximo espesor de corte: 14cm
Tamaño de disco: 30-45cm[12"-18"]
Manejo por empuje manual
Tanque de agua: 35L
Tanque de gasolina: 2.8L



Apisonadora compactadora a gasolina

TP880-2

INDUSTRIAL

6.5HP

NEW

Potencia
4.8 Kw

kg
79

2.0L

Potencia: 4.8Kw [6.5HP]
Fuerza de impacto: 10kN
Altura de salto: 65mm
Tasa de impacto: 450-660 rpm
Tanque: 2.0L
Medida de zapato: 33x29cm
Peso: 79Kg



16"



TAC2144052
Disco de diamante 16",
Para cortar concreto,
Espesor 10mm
Soldado con láser

TAC2164051
Disco de diamante 16",
Para cortar asfalto,
Espesor 10mm
Soldado con láser

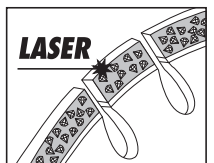

Modelo mejorado

NEW

TP1016-2



Compactadora de plato reversible a gasolina

TP7125-2

INDUSTRIAL

6.5HP

Potencia: 4.8Kw (6.5HP)
 Fuerza centrífuga: 25kN
 Frecuencia: 4300vpm
 Profundidad de compactación: 30cm
 Velocidad de avance: 25cm/s
 Eficiencia: 500m²/Hr
 Medida del plato: 63x40cm



- Compactación superior en cualquier dirección, hacia adelante y atrás.
- Ideal para arena, grava y mezcla de suelos en zanjas estrechas y a lo largo de cimientos, muros y pilares.
- Soportes de impacto heavy duty reducen la vibración.
- Posee barras de protección que evita daños en el equipo por accidentes en el lugar de trabajo.
- Placas de soporte resistentes al desgaste.



Compactadora de plato a gasolina

TP7100-2

INDUSTRIAL

6.5HP

Motor: TOTAL
 Potencia: 4.8Kw (6.5HP)
 Fuerza centrífuga: 15kN
 Frecuencia: 4200vpm
 Profundidad de compactación: 30cm
 Velocidad de avance: 45cm/s
 Eficiencia: 660m²/Hr
 Medida del plato: 50x45cm



- Ideal para compactar arena, grava y materiales granulares..
- Asa plegable para facilitar el transporte y el almacenamiento.
- Placa base con bordes curvos para facilitar el acceso a las esquinas.
- Cubierta de la correa sellada para evitar la entrada de arena y tierra.
- Soportes de impacto heavy duty reducen la vibración.



Vibrador de concreto a gasolina

TP630-2

INDUSTRIAL

5.5HP

Motor: TOTAL
 Potencia: 4.0Kw (5.5HP)
 Acoplamiento tipo garra
 No incluye el poker de vibración
 (comprar aparte el cód. TPVPO451)



Poker de vibración para TP630-2

TPV1451

INDUSTRIAL



Tubo garra



Diámetro: 45mm
 Longitud de la cabeza: 580mm
 Frecuencia de vibración: 200Hz
 Amplitud vibrante: 1.2mm
 Longitud flexible de la manguera: 6m
 Acoplamiento tipo garra

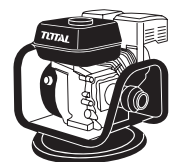

Mezclador de concreto a gasolina

TCM35021

INDUSTRIAL

9HP

Motor: Honda GX270
Potencia: 6.6Kw (9.0HP)
Capacidad: 350L
Velocidad del tambor: 20/min

- Anillo de engranaje de fundición de hierro especial.
- Marco plegable para fácil almacenamiento y transporte.
- Gran diámetro del tambor para excelentes resultados de mezcla.
- Eje de transmisión colocado sobre rodamiento sellado.



Motor
HONDA
GX270



Helicópteros para concreto a gasolina

TP9361-1 (4.0Kw), TP9361-2 (4.8Kw)

INDUSTRIAL

Motor: Honda GX160 / TOTAL petrol engine
Potencia: 4.0Kw (5.5HP) / 4.8Kw (6.5HP)
Diámetro de rotor: 91cm (36")
Número de cuchillas: 4
Medidas de las hojas de acabado: 35x15cm (6x14")

- Diseño resistente para asegurar un acabado superior.
- Interruptor de seguridad para una operación más segura.
- Tornillo ajustable garantiza un ajuste preciso de la cuchilla.



CÓDIGO: TP9361-1

Motor
HONDA
GX160



36"

CÓDIGO: TP9361-2

MODELO ECONÓMICO

Motor
TOTAL



36"

Compresor de aire

UTC120242

INDUSTRIAL

Voltaje: 110V~50/60Hz
 Potencia: 1.5 kW [2.0HP]
 Velocidad sin carga: 2850/min
 Volumen de tanque: 24L [6.3Gal]
 Presión: max. 8 bar [116psi]
 Nivel de ruido: 96 db
 Desplazamiento del aire: 93L/min@40psi (2.7bar)

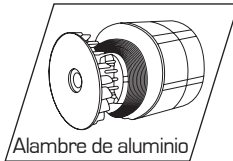

Compresor de aire

UTC125502

INDUSTRIAL

Voltaje: 110V~50/60Hz
 Potencia: 1.8 kW [2.5HP]
 Velocidad sin carga: 2850/min
 Volumen de tanque: 50L [13.2Gal]
 Presión: max. 8 bar [116psi]
 Nivel de ruido: 96 db
 Desplazamiento del aire: 119L/min@40psi (2.7bar)

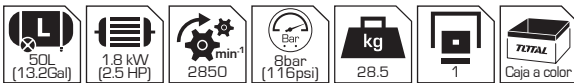
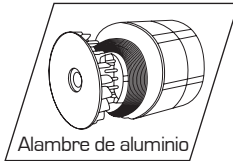

Compresor de aire

UTC1301006

INDUSTRIAL

Voltaje: 110V~50/60Hz
 Potencia: 2.2 kW [3.0HP]
 Velocidad sin carga: 1100/min
 Volumen de tanque: 100L [26.4Gal]
 Presión: max. 8 bar [116psi]
 Nivel de ruido: 92 db
 Desplazamiento del aire: 144L/min@101psi (7bar)

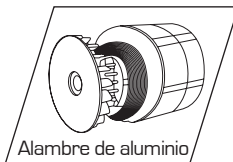

Sistema accionado por correa



Compresor de aire

UTCS1075248 INDUSTRIAL

Voltaje: 110V~50/60Hz
Potencia: 600W (0.8HP)
Velocidad sin carga: 1600/min
Volumen de tanque: 24L (6.3Gal)
Presión: max. 8 bar (116psi)
Nivel de ruido: 60 db
No utiliza aceite

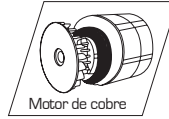
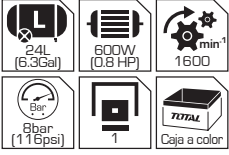

0.8HP



Compresor de aire

UTCS1120508 INDUSTRIAL

Voltaje: 110V~50/60Hz
Potencia: 1200W (1.6HP)
Velocidad sin carga: 3400/min
Volumen de tanque: 50L (13.2Gal)
Presión: max. 8 bar (116psi)
Nivel de ruido: 75 db
No utiliza aceite

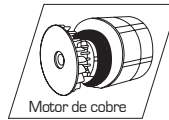
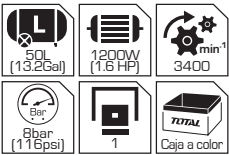

1.6HP

SUPER SELECT



Pistola de aire

TAT10401 INDUSTRIAL

400cc

- Capa base
- Acabado final



Pistola de aire

TAT11001 INDUSTRIAL

1000cc

- Capa base
- Acabado final

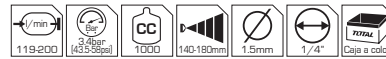

Pistola de aire

TAT10402 INDUSTRIAL

400cc

- Capa base
- Acabado final

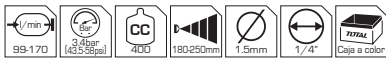

Pistola de aire

TAT11005 INDUSTRIAL

1000cc

- Capa base
- Acabado final

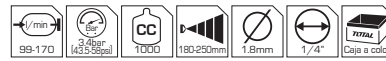

Pistola de aire

TAT11002 INDUSTRIAL

1000cc

- Capa base
- Acabado final

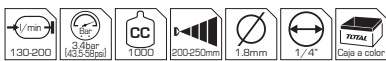

Pistola de aire

TAT10601 INDUSTRIAL

600cc

- Capa base
- Acabado final



HVLP

Pistola de aire

TAT11004

INDUSTRIAL

1000cc

- Capa base
- Acabado final



HVLP

10

Pistola de aire

TAT10605

INDUSTRIAL

600cc

- Capa base
- Acabado final

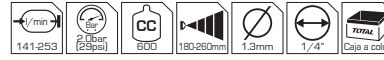

LVMP

10

Pistola de tolva pulverizadora para texturizar

TAT1205

INDUSTRIAL

5 LT

NEW

Boquilla: 4.5mm
Presión: 4.0 bar (58psi)
Consumo de aire: 250 L / min (8.8 cfm)



4

Pistola de lavado de aire

TAT20751

INDUSTRIAL

750cc

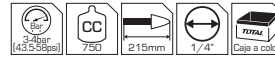

Pistola de aire

TAT3031.1

INDUSTRIAL

16mm

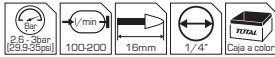

50

Kit de 5 herramientas de aire

TATK053-1

INDUSTRIAL

SUPER SELECT



x5 Manguera: 4 mt, dia. 8mm
Pistola de aire: boquilla de 16mm
Pistola de lavar: 3-4 bar, 600cc
Pistola de lavado: 4 bar, 750cc
Pistola para inflar neumáticos: 12 bar

10

Llave de impacto de aire de 1/2"

TAT41125

INDUSTRIAL

SUPER SELECT

312Nm

Punta cuadrada: 1/2" (12.5mm)
Velocidad sin carga: 7000/min
Máx. torque: 312 Nm (230ft)
Presión máxima: 6.3 bar (90psi)
Flujo de aire: 142.5 L / min (5.0 cfm)
Entrada de aire: 1/4"
Manguera de aire: 3/8"
Incluye 10 pcs de sockets (9, 10, 11, 13, 14, 17, 19, 22, 24, 27mm)

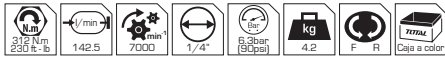

6

Llave de impacto de aire de 1/2"

TAT40122

INDUSTRIAL

610Nm

Punta cuadrada: 1/2" (12.5mm)
Velocidad sin carga: 7000/min
Máx. torque: 610 Nm (450ft)
Presión máxima: 6.2 bar (90psi)
Flujo de aire: 142.5 L / min (5.0 cfm)
Entrada de aire: 1/4"
Manguera de aire: 3/8"
Incluye 3 pcs de sockets (17 mm, 19 mm, 21 mm)

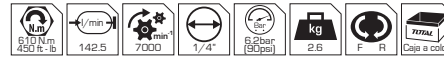

6

Llave de impacto de aire de 3/4"

TAT40341

INDUSTRIAL

1355Nm

Punta cuadrada: 3/4" (19mm)
Velocidad sin carga: 7000/min
Máx. torque: 1355 Nm (1000ft)
Presión máxima: 6.2 bar (90psi)
Flujo de aire: 269 L / min (9.5 cfm)
Entrada de aire: 3/8"
Manguera de aire: 1/2"

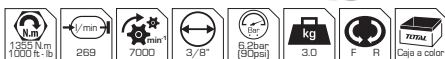

6

Llave de impacto de aire de 3/4"

TAT40342

INDUSTRIAL

1600Nm

Punta cuadrada: 3/4" (19mm)
Velocidad sin carga: 4000/min
Máx. torque: 1600 Nm (1180ft)
Presión máxima: 6.2 bar (90psi)
Flujo de aire: 256 L / min (9 cfm)
Entrada de aire: 3/8"
Manguera de aire: 1/2"

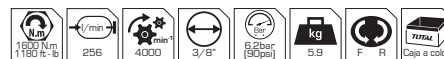

4

Llave de impacto de aire de 1"

TAT41112

INDUSTRIAL

1800Nm

Punta cuadrada: 1" (25mm)
Velocidad sin carga: 4000/min
Máx. torque: 1800 Nm (1328ft)
Presión máxima: 6.2 bar (90psi)
Flujo de aire: 256 L/min (9 cfm)
Entrada de aire: 3/8"
Manguera de aire: 1/2"

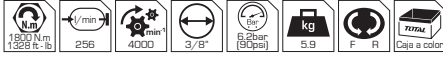

Llave de trinquete de aire de 1/2"

TAT10121

INDUSTRIAL

68Nm

Punta cuadrada: 1/2" (12.5mm)
Velocidad sin carga: 160/min
Máx. torque: 68 Nm (50ft)
Presión máxima: 6.2 bar (90psi)
Flujo de aire: 85.5 L/min (3 cfm)
Entrada de aire: 1/4"
Manguera de aire: 3/8"

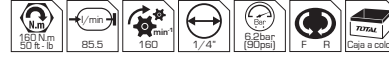

Llave de impacto de aire de 1"

TAT40111

INDUSTRIAL

3100Nm

Punta cuadrada: 1" (25mm)
Velocidad sin carga: 3600/min
Máx. torque: 3100 Nm (2300ft)
Capacidad del perno: 45 mm (1-3/4")
Flujo de aire: 1019 L/min (36 cfm)
Entrada de aire: 1/2"
Manguera de aire: 1/2"



Lijadora de aire

TAT91501

INDUSTRIAL

6"

Tamaño de almohadilla: 6" (150mm)
Velocidad sin carga: 10000/min
Presión máxima: 6.2 bar (90psi)
Flujo de aire: 79.2 L/min (2.8 cfm)
Entrada de aire: 1/4"

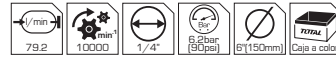

Pistola infladora neumática

TAT11601

INDUSTRIAL

8.5 bar

Presión máxima: 8.5 bar (120psi)

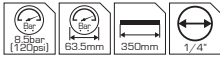

Pistola de clavos de aire

TAT83301

INDUSTRIAL

GA18

Capacidad: 100 pcs
Gatillo de seguridad
Medida clavo: 10 - 30 mm,
Ga18, 1.25x1.0 mm
Presión de operación:
0.4 - 0.7 Mpa (60-100 Psi)



Pistola de clavos de aire

TAT83501

INDUSTRIAL

GA18

Capacidad: 100 pcs
Gatillo de seguridad
Medida clavo: 15 - 50 mm,
Ga18, 1.25x1.0 mm
Presión de operación:
0.4 - 0.7 Mpa (60-100 Psi)



2 en 1 clavadora/ engrapadora

TAT81501

INDUSTRIAL

GA18

Capacidad: 100 pcs
Medida clavo: 15 - 50 mm
Ga18, 1.25x1.0 mm
Medida grapa: 16 - 40 mm
Ga18, 1.25x1.0 mm
Ancho de grapa: 5.7 mm
Presión de operación: 0.4 - 0.7 Mpa (60-100 Psi)
Incluye 1000 pcs clavos / 1000 pcs grapas



Pistola de clavos de aire para concreto

TAT8641

INDUSTRIAL

GA18

Capacidad: 70 pcs
Medida clavo: 18 - 64 mm,
Diámetro de clavo: Ø 2.2mm
Presión de operación:
0.5 - 0.8 Mpa (75-116 Psi)



Ø 2.2mm

18 - 64mm

Clavos para clavadora

GA18



Longitud
Ga18 (1.25-1.0mm)

5000 piezas por caja



Código	Longitud
TAC918151	15mm
TAC918201	20mm
TAC918251	25mm
TAC918301	30mm

Clavos para clavadora

GA18

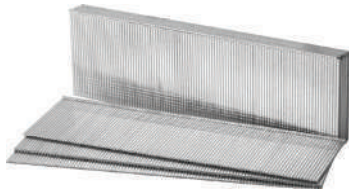
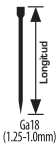

5000 piezas por caja



Código	Longitud
TAC918351	35mm
TAC918381	38mm
TAC918401	40mm
TAC918501	50mm

Grapas para engrapadora

GA18

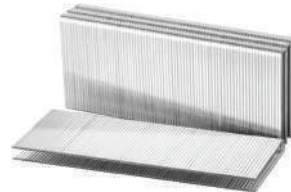

2500 piezas por caja



Código	Longitud
TAC918252	25mm
TAC918352	35mm
TAC918382	38mm
TAC918402	40mm

Clavos para pistola de concreto

GA18

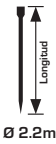

1000 piezas por caja

Código	Longitud
TAC918183	18mm
TAC918253	25mm
TAC918323	32mm
TAC918383	38mm
TAC918503	50mm
TAC918643	64mm

Pistola de aire comprimido

1/4"

16mm



Código	Diámetro
TAT601001	1/4"

Set de 17 piezas para pistola de aire

1/4"

Incluye pistola, acople rápido hembra y macho



Código	Diámetro
TAT617931	1/4"

Manguera de aire

10mts



Código	Largo	Diámetro
THT11101.1	10m	6/8mm

Manguera de aire

15mts



Código	Largo	Diámetro
THT11151.1	15m	5/8mm

Acople rápido macho Tipo Americano

1/4"



Código	Diámetro
TAT6015651	1/4"

Acople rápido hembra Tipo Americano

1/4"



Código	Diámetro
TAT6015551	1/4"

Set 2 piezas de acople rápido macho, Tipo Americano

1/4"



Código	Diámetro
TAT6025651	1/4"

Set 2 piezas de acople rápido hembra, Tipo Americano

1/4"



120

Código	Diámetro
TAT6025551	1/4"

Acople rápido rosca macho Tipo Americano

1/4"



120

Incluye acoplador rosca macho Chapado en cobre

Código	Diámetro
TAT6011631	1/4"

Acople rápido rosca hembra Tipo Americano

1/4"



120

Incluye acoplador rosca hembra Chapado en cobre

Código	Diámetro
TAT6011531	1/4"

Acople rápido rosca macho Tipo Americano

1/4"



120

Incluye acoplador rosca macho Material cobre

Código	Diámetro
TAT6012671	1/4"

Acople rápido rosca hembra Tipo Americano

1/4"



120

Incluye acoplador rosca hembra Material cobre

Código	Diámetro
TAT6012571	1/4"

Juego de 4 piezas de acoples rápidos

1/4"



80

Acopladores de rosca hembra y macho

Código	Diámetro
TAT604931	1/4"



Cortadora de césped a gasolina
TGT141181 INDUSTRIAL

Potencia: 3.0KW (4HP)
 Desplazamiento: 141 cc
 Velocidad sin carga: 2600/min
 Cesta de recolección: 60L
 Carcasa de acero

18" **TAC0214601**
 Disco de corte

3.0 KW (4HP)
 2600
 60L
 Motor de 4 tiempos
 Caja a color

Motocultor diesel
TDC12001 INDUSTRIAL

5.2HP **NEW**

Potencia: 4.05KW (5.2HP)
 Alance de labranza: 1200 mm
 Profundidad de labrado: 150-300 mm
 Cambio de marcha: -1, 2, 0, 1
 Torque máx. (N.m/Rpm): 9/2800
 Capacidad de aceite: 1.6 L

1200 mm
 4 cambios
 150-300 mm
 9 N.m

Cultivador a gasolina
TGC5001 INDUSTRIAL

6.5HP

Potencia: 4.8KW (6.5HP)
 Alance de labranza: 900 mm
 Profundidad de labrado: 150-300 mm
 Cambio de marcha: -1, 2, 0, 1
 Torque máx. (N.m/Rpm): 11/2500
 Capacidad de aceite: 0.95 L

900 mm
 4 cambios
 150-300 mm
 11 N.m

Cultivador a gasolina
TGC12001 INDUSTRIAL

7.0HP **NEW**

Potencia: 5.1KW (7.0HP)
 Alance de labranza: 1200 mm
 Profundidad de labrado: 150-300 mm
 Cambio de marcha: -1, 2, 0, 1
 Torque máx. (N.m/Rpm): 11/2800
 Capacidad de aceite: 1.6 L

1200 mm
 4 cambios
 150-300 mm
 11 N.m

Motocultor diesel
TDC13501 INDUSTRIAL

9.0HP **NEW**

Potencia: 6.6KW (9.0HP)
 Alance de labranza: 1350 mm
 Profundidad de labrado: 300 mm
 Cambio de marcha: -1, 2, 0, 1
 Torque máx. (N.m/Rpm): 18.5/2800
 Capacidad de aceite: 1.8 L

1350 mm
 4 cambios
 300 mm
 18.5 N.m

Barrenador de tierra
TEA55221 INDUSTRIAL

1.8HP

Potencia: 1.4KW (1.8HP)
 Desplazamiento: 52cc
 Velocidad de perforado: 0 - 265/min
 Tanque de gasolina: 1200ml
 Motor de 2 tiempos
 Velocidad max. del motor: 9000/min
 Velocidad ralentí: 3300±300
 Longitud de broca: Ø150 x 800mm

1.4 KW (1.8HP)
 9000
 1200ml
 Motor de 2 tiempos
 Caja a color

Motosierra
TG5451811 INDUSTRIAL

2.5HP

Potencia: 1.8KW (2.5HP)
 Desplazamiento: 46cc
 Velocidad sin carga: 3100/min
 Tanque de gasolina: 550ml/aceite 260m
 Sierra de cadena Oregon
 Motor de 2 tiempos

TGTS51801
 Cadena de sierra Oregon

TGTSB51801
 Barra guía para sierra 18"

1.8 KW (2.5HP)
 3100
 260/550ml
 460mm(18")
 Caja a color

Motosierra
TG5602411 INDUSTRIAL

3.2HP

Potencia: 2.4KW (2.5HP)
 Desplazamiento: 62cc
 Velocidad sin carga: 3100/min
 Tanque de gasolina: 550ml/aceite 260m
 Sierra de cadena Oregon
 Motor de 2 tiempos

TGTS52401
 Cadena de sierra Oregon

TGTSB52401
 Barra guía para sierra 24"

2.4 KW (2.5HP)
 3100
 260/550ml
 610mm(24")
 Caja a color

Motosierra
TG962241 INDUSTRIAL

4.2HP

Potencia: 3.2KW (4.2HP)
 Desplazamiento: 62cc
 Velocidad sin carga: 3200/min
 Tanque de gasolina: 670ml/aceite 350ml
 Sierra de cadena Oregon
 Diámetro de barra 24"
 Motor de 2 tiempos

TGTS52401
 Cadena de sierra Oregon

TGTSB52401
 Barra guía para sierra 24"

3.2 KW (4.2HP)
 3200
 350/670ml
 610mm(24")
 Caja a color

Cortadora de setos a gasolina
TGT5265511 INDUSTRIAL

1HP

Potencia: 0.75KW (1HP)
 Desplazamiento: 25.4cc
 Velocidad sin carga: 10000/min
 Tanque de gasolina: 550ml
 Motor de 2 tiempos
 Largo de barra 550mm

0.75 KW (1HP)
 10000
 550ml
 21.5"
 Motor de 2 tiempos
 Caja a color

Picadora de Madera
TWCS350 INDUSTRIAL

212CC 7.0HP
 Up to 600kg/h

Potencia: 4.5KW / 3600rpm
 Capacidad de astillado: 50mm
 Eficiencia de astillado: 600kg/h
 Tamaño del astillado procesado: 7-25mm
 Parada de emergencia
 Peso Neto: 90Kg

NEW Max. Ø50mm

4.5 KW (7.0HP)

Picadora de Madera
TWCS3100 INDUSTRIAL

459CC 15HP
 Up to 1000kg/h

Potencia: 10KW / 3600rpm
 Capacidad de astillado: 100mm
 Eficiencia de astillado: 1000kg/h
 Tamaño del astillado procesado: 7-35mm
 Parada de emergencia
 Peso Neto: 125Kg

NEW Max. Ø100mm

10 KW (15HP)

Multi herramienta
TMT55211 INDUSTRIAL

1.7HP

Potencia: 1.25KW (1.7HP)
 Desplazamiento: 43cc
 Velocidad sin carga: 10000/min
 Tanque de gasolina: 1200ml
 Motor de 2 tiempos
 Corte máximo: 420mm
 Rollo de línea: 2.4mmx4m

1.25 KW (1.7HP)
 10000
 1200ml
 225mm(10)
 Caja a color

Desmalezadora (Wira) a gasolina
TP53144141 INDUSTRIAL

1.1HP

Potencia: 0.7KW (1.1HP)
 Desplazamiento: 31cc
 Velocidad sin carga: 9300/min
 Rollo de línea: 2.4mmx4m
 Diámetro de corte: 480mm

Removable

MOTOR DE 4 TIEMPOS

0.7 KW (1.1HP)
 9300
 Motor de 4 tiempos
 700ml
 225mm(10)
 Ø480mm(19)
 Caja a color

Desmalezadora (Wira) a gasolina
TP5434421 INDUSTRIAL

2HP

Potencia: 1.25KW (2HP)
 Desplazamiento: 42.7cc
 Velocidad sin carga: 9000/min
 Rollo de línea: 2.4mmx4m
 Diámetro de corte: 420mm

Removable

TGTL52545 Línea de Ø 2.5mm (4mts) repuesto
TGTL1261 Línea de Ø 1.2mm (6mts) repuesto

TGTBC895 Disco de corte 9" repuesto
TAC234615 Disco de corte 9" repuesto

1.25 KW (2HP)
 9000
 Motor de 2 tiempos
 1200ml
 225mm(10)
 Ø420mm(17)
 Caja a color

Desmalezadora (Wira) a gasolina
TP5524411 INDUSTRIAL

2.2HP

Potencia: 1.4KW (2.2HP)
 Desplazamiento: 52cc
 Velocidad sin carga: 9000/min
 Rollo de línea: 2.4mmx4m
 Diámetro de corte: 420mm

Removable

MOTOR DE 2 TIEMPOS

1.4 KW (2.2HP)
 9000
 Motor de 2 tiempos
 1200ml
 225mm(10)
 Ø420mm(17)
 Caja a color

Desmalezadora (Wira) a gasolina
TP5624421 INDUSTRIAL

3.8HP

Potencia: 2.4KW (3.8HP)
 Desplazamiento: 62cc
 Velocidad sin carga: 9000/min
 Rollo de línea: 2.4mmx4m
 Diámetro de corte: 480mm

Removable

2.4 KW (3.8HP)
 9000
 Motor de 2 tiempos
 1200ml
 225mm(10)
 Ø480mm(19)
 Caja a color

Nylon redondo para desmalezadora
2.4-3.3-4.0mm INDUSTRIAL

LARGO DE CADENA 25cm

NEW

2.4-3.3-4.0mm

Código	Medida	Longitud
TSL2421	2.4mm	21m
TSL3311	3.3mm	11m
TSL4030	4.0mm	30m

Cabezal de nylon para cortagrama.
ALS24252 INDUSTRIAL

DIAMETRO DE LINEA 2.4mm

NEW

Diámetro de la línea: 2.4mm
 Longitud de la línea: 2.5M
 Longitud saliente de un solo lado: 10cm
 Embalado en blister doble.

Cabezal de cadena para cortagrama
ALS25001 INDUSTRIAL

LARGO DE CADENA 25cm

NEW

Longitud de la cadena: 2.4mm
 Longitud saliente de un solo lado: 10cm
 Embalado en blister doble.

Sopladora de aire a gasolina

TB543201

INDUSTRIAL

1.7HP

Potencia: 1.25KW (1.7HP)
Desplazamiento: 42.7cc
Velocidad de motor: 7000/min
Tanque de gasolina: 1L
Motor de 2 tiempos
Volumen de aire: 0.2m³/s

MOTOR DE 2 TIEMPOS



Fumigadora de mochila a gasolina

TP541141

INDUSTRIAL

2.8HP

Potencia: 2.13KW (2.8HP)
Desplazamiento: 41.5cc
Capacidad de químico: 14L
Velocidad de motor: 7500/min
Tanque de gasolina: 1.4L
Motor de 2 tiempos

14L

MOTOR DE 2 TIEMPOS



Hidrolavadora

UTGT113026

INDUSTRIAL

1200W

Voltaje: 110 - 120V~50/60Hz
Potencia: 1200W
Presión máxima: 90 bar (1300psi)
Flujo máximo: 5.5L/min
Sistema de pagado automático
Manguera de 3 mts
Incluye pistola de agua

SUPER SELECT

NEW



Hidrolavadora

UTGT11316

INDUSTRIAL

1400W

Voltaje: 110 - 120V~50/60Hz
Potencia: 1400W
Presión máxima: 130 bar (1900psi)
Flujo máximo: 5.5L/min
Sistema de pagado automático
Manguera de 5 mts
Incluye pistola de agua

TGTSG026
Pistola

TGTPCH751
Manguera (7.5m)

TGTHPH526
Manguera (5m)



Hidrolavadora

UTGT11356

INDUSTRIAL

1800W

Voltaje: 110 - 120V~50/60Hz
Potencia: 1800W
Presión máxima: 150 bar (2200psi)
Flujo máximo: 6.0L/min
Sistema de pagado automático
Manguera de 5 mts
Incluye pistola de agua

TGTSG026
Pistola

TGTPCH751
Manguera (7.5m)

TGTHPH526
Manguera (5m)



Hidrolavadora a gasolina

TGT250105

INDUSTRIAL

6.0HP

Potencia: 6.0HP / 206 bar (3000PSI)
Desplazamiento: 208cc
Motor: OHV de 4 tiempos
Velocidad sin carga: 3600/min
Tanque de gasolina: 3.6L
Pistola de metal con manguera de 7.6mm y 4 boquillas

TGT250103-SP-34



Hidrolavadora a gasolina

TGT250206

INDUSTRIAL

7.0HP
235Bar
(3450PSI)

Potencia: 7.0HP / 235 bar (3450PSI)
Desplazamiento: 212cc
Motor: OHV de 4 tiempos
Velocidad sin carga: 3600/min
Tanque de gasolina: 3.6L
Pistola de metal con manguera de 9.1m y 4 boquillas
Flujo máximo: 9.5L/min

7.0HP

NEW



Bomba con función de cambio de aceite



Hidrolavadora a gasolina

TGT250306

INDUSTRIAL

13.5L/min 282Bar 500H

Potencia: 8.5HP / 285 bar (4089PSI)
Desplazamiento: 274cc
Motor: OHV de 4 tiempos
Velocidad sin carga: 3600/min
Incluye lanza, pistola de metal y 5 boquillas
Flujo máximo: 13.5L/min

8.5HP

NEW



Aspiradora

UTVC14122

INDUSTRIAL

800W

Húmedo y seco

Filtro de aire de repuesto

Manguera de repuesto



UTVC14122-SP-26 **UTVC14122-SP-29**

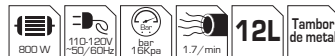

Aspiradora

UTVC10101

INDUSTRIAL

800W

Húmedo y seco

NEW

1000W

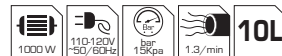

Aspiradora
UTVC14301 INDUSTRIAL

Filtro de aire de repuesto HEPA
1400W
HÚMEDO
SECO

TVCAIHPO2

1400 W 110-120V 30/60Hz 18,18Kpa 1,9/min 30L Tambor de acero inox

1

Aspiradora inalámbrica
TVCH14111 INDUSTRIAL

Voltaje: 22.2V
Potencia: 120W
Presión máxima: 150 bar (2200psi)
Capacidad: 0.8L
Batería de litio 2200 Amh
Presión de vacío: ≥9Kpa
Tiempo de trabajo: 35 min - nivel de velocidad baja
18 min - nivel de velocidad alta

COO. ANTIGUO COO. NUEVO
TVCH14111 - TVL12006

120 W 22.2V 120W 0.8L FILTRO HEPA Caja a color

2

Aspiradora robótica (estilo giroscopio)
TVCRG30261 INDUSTRIAL

Recorrido inteligente de limpieza
Control remoto
Batería de litio 2000 Amh
Sensores de detección
Limpieza en seco
Tiempo de trabajo: 50 - 70 min
Presión de vacío: 600-900Pa

RUTA DE LIMPIEZA AUTOMÁTICA ORGANIZADA

50-70min 600-900Pa Caja a color

4

Pistola para hidrolavadora
TGTSG026 INDUSTRIAL

Conector rápido
Cuerpo de plástico resistente

Compatible con hidrolavadora UTGT11316, UTGT11356

4

Boquilla con envase para producir espuma
TMFP402 INDUSTRIAL

Capacidad: 400ml
Cuerpo de plástico resistente
Tamaño: 125x85x196mm

NEW

25

Manguera de alta presión
TGTHPH526 INDUSTRIAL

Longitud de 5 metros
Material: PVC

Compatible con hidrolavadora UTGT11316, UTGT11356

16

Cepillo horizontal
TGTHB2791 INDUSTRIAL

Medida: 270x95 mm
Material: PP y PA66+30GF
Con varilla de extensión de 455 mm

Compatible con la pistola para hidrolavadora TGTSG026

20

Cepillo de patio
TGTPB251 INDUSTRIAL

Medida: 250 mm
Material: PP y PA66+30GF
Con varilla de extensión de 455 mm

Compatible con la pistola para hidrolavadora TGTSG026

5

Cepillo de rueda
TGTWB1781 INDUSTRIAL

Medida: largo 390 mm

Compatible con la pistola para hidrolavadora TGTSG026

20

Boquilla con ángulo de 45°
TGTAN4501 INDUSTRIAL

Medida: largo 590 mm
Ángulo de 45°

Compatible con la pistola para hidrolavadora TGTSG026

50

Bomba periférica

UTWP13706

INDUSTRIAL

0.5HP

Voltaje: 110 - 120V~50/60Hz
Potencia: 370W (0.5HP)
Altura de elevación: 35M
Flujo máximo: 35L/min
Máxima succión: 8M
Diámetro del tubo: 1"x1"
Motor de alambre de cobre
Impulsor de cobre



6

Bomba periférica

UTWP13706A-24

INDUSTRIAL

0.5HP

Voltaje: 110 - 120V~50/60Hz
Potencia: 370W (0.5HP)
Altura de elevación: 35M
Flujo máximo: 35L/min
Máxima succión: 8M
Diámetro del tubo: 1"x1"
Motor de alambre de cobre
Impulsor de cobre
Con tanque de presión de 24 L



Bomba periférica

UTWP137016

INDUSTRIAL

0.5HP



SUPER SELECT

Voltaje: 110 - 120V~50/60Hz
Potencia: 370W (0.5HP)
Altura de elevación: 30M
Flujo máximo: 30L/min
Máxima succión: 8M
Diámetro del tubo: 1"x1"
Motor de alambre de cobre
Impulsor de cobre



1

Bomba periférica autocebante

UTWP93706

INDUSTRIAL

0.5HP



Voltaje: 110 - 120V~50/60Hz
Potencia: 370W (0.5HP)
Altura de elevación: 32M
Flujo máximo: 35L/min
Máxima succión: 8M
Diámetro del tubo: 1"x1"
Motor de alambre de cobre
Impulsor de cobre



1

Bomba periférica

UTWP15506

INDUSTRIAL

0.75HP

Voltaje: 110 - 120V~50/60Hz
Potencia: 550W (0.75HP)
Altura de elevación: 45M
Flujo máximo: 45L/min
Máxima succión: 8M
Diámetro del tubo: 1"x1"
Motor de alambre de cobre
Impulsor de cobre



1

Bomba periférica

UTWP17506

INDUSTRIAL

1.0HP

Voltaje: 110 - 120V~50/60Hz
Potencia: 750W (1HP)
Altura de elevación: 50M
Flujo máximo: 60L/min
Máxima succión: 8M
Diámetro del tubo: 1"x1"
Motor de alambre de cobre
Impulsor de cobre



1

Bomba de inyección autocebante

UTWP37506

INDUSTRIAL

1.0HP

Voltaje: 110 - 120V~50/60Hz
 Potencia: 750W (1.0HP)
 Altura de elevación: 51M
 Flujo máximo: 55L/min
 Máxima succión: 9M
 Diámetro del tubo: 1"x1"
 Impulsor de bronce

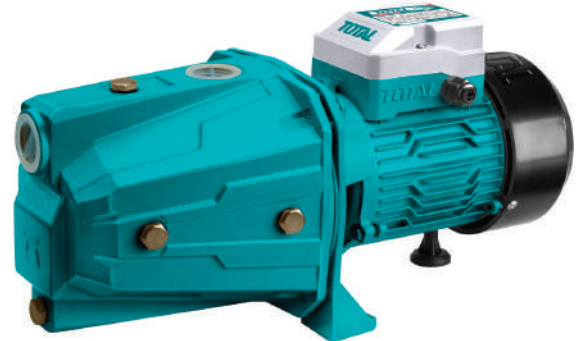
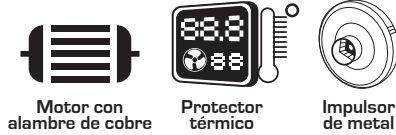

Bomba de inyección autocebante automática

UTWP47506

INDUSTRIAL

1.0HP

Voltaje: 110 - 120V~50/60Hz
 Potencia: 750W (1.0HP)
 Altura de elevación: 45M
 Flujo máximo: 60L/min
 Máxima succión: 9M
 Diámetro del tubo: 1"x1"
 Impulsor de bronce

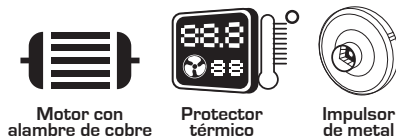

Bomba de inyección autocebante automática

UTWP27506

INDUSTRIAL

1.0HP

Voltaje: 110 - 120V~50/60Hz
 Potencia: 750W (1.0HP)
 Altura de elevación: 30M
 Flujo máximo: 120L/min
 Máxima succión: 8M
 Diámetro del tubo: 1"x1"
 Impulsor de acero inoxidable

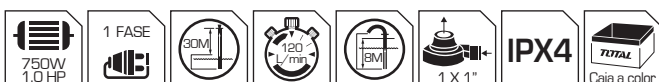

Bomba sumergible de aguas residuales

UTWP87506 INDUSTRIAL

Voltaje: 110 - 120V~50/60Hz
 Potencia: 750W (1.0HP)
 Altura de elevación: 8M
 Flujo máximo: 13m³
 Máxima profundidad de succión: 5M
 Diámetro de tubo: 1"
 Cable de 9 mts de largo

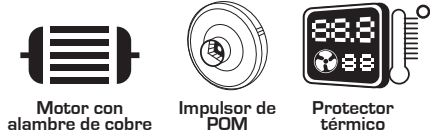

Motor con alambre de cobre

Impulsor de POM

Protector térmico

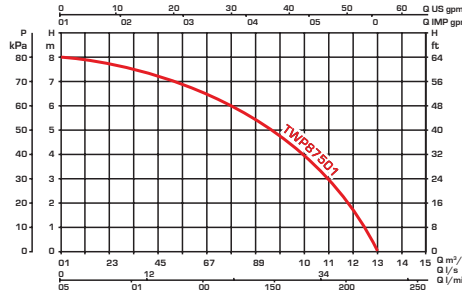

Las curvas de rendimiento se basan en los valores de viscosidad cinemática = 1 mm²/s y densidad igual a 1000 kg/m³. Tolerancia de curva según ISO 9906



2



Bomba sumergible de aguas residuales

UTWP7150026 INDUSTRIAL

Voltaje: 110 - 120V~50/60Hz
 Potencia: 1500W (2.0HP)
 Altura de elevación: 14.5 M
 Flujo máximo: 20m³
 Diámetro de tubo: 2"
 Carcasa de acero inoxidable
 Cable de 9 mts de largo
 Incluye hoja de corte



Motor con alambre de cobre

Impulsor de hierro fundido

Cuerpo de acero inox.

Protector térmico

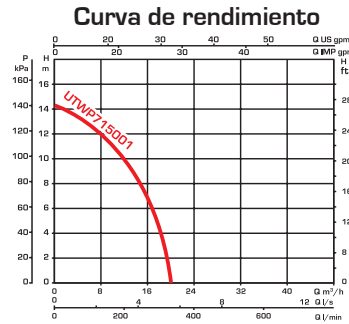

Las curvas de rendimiento se basan en los valores de viscosidad cinemática = 1 mm²/s y densidad igual a 1000 kg/m³. Tolerancia de curva según ISO 9906



2.0HP

1

Bomba de pozo profundo cuerpo de 4"

UTWP53701 - UTWP511001 INDUSTRIAL

Voltaje: 110 - 120V~50/60Hz
 Potencia: 370W (0.5HP) / 1100W (1.5HP)
 Altura de elevación: 48M / 112M
 Flujo máximo: 6.0m³/H
 Diámetro de tubo: 1 1/4"
 Impulsor: 6 etapas / 14 etapas
 Exterior de bomba de acero inoxidable
 No incluye caja de control



Cuerpo de acero inox.

Protector térmico



Motor con alambre de cobre



Impulsor de bomba

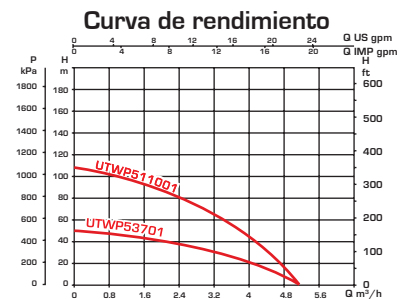

Las curvas de rendimiento se basan en los valores de viscosidad cinemática = 1 mm²/s y densidad igual a 1000 kg/m³. Tolerancia de curva según ISO 9906

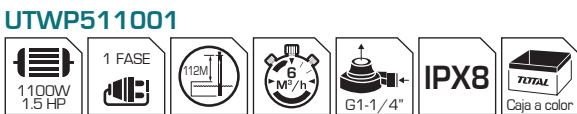

1

Caja de control para bomba de pozo profundo 4"

UTWP53701-SB - UTWP511001-SB

INDUSTRIAL



Voltaje: 110 - 120V~50/60Hz
Cable de 70 cm de largo
Protector de voltaje incorporado



Línea de cable

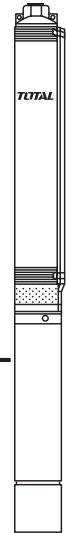
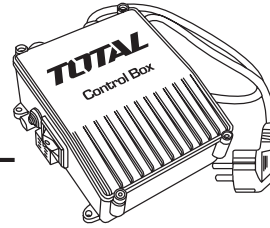

Bomba de pozo profundo

Código	Voltaje	Amperios	Condensador	Compatible
UTWP53701-SB	110-120V~60Hz	15 AMP	25 µF	UTWP53701
UTWP511001-SB	110-120V~60Hz	35 AMP	30 µF	UTWP511001

5

Control automático para bomba periférica

UTWPS101

INDUSTRIAL

1.5HP

Voltaje: 110 - 120V~50/60Hz
Potencia: 1100W
Presión inicial: 1.5 bar [22psi]
Corriente máxima: 10A
Presión máxima: 10bar [145psi]
Diámetro de la tubería: 1"x1"
Grado de protección: IP65



Dirección del flujo de agua

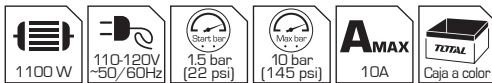

12

Control automático para bomba periférica

UTWPS102

INDUSTRIAL

1100W

Voltaje: 110 - 120V~50/60Hz
Potencia: 1100W
Presión inicial: 1.5 bar [22psi]
Corriente máxima: 10A
Presión máxima: 10bar [145psi]
Diámetro de la tubería: 1"x1"
Grado de protección: IP65



Dirección del flujo de agua

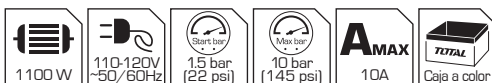

12

Brocas HSS

INDUSTRIAL



- Torsión hecha en acero de alta velocidad fabricado para Din 338
- Punto de hendidura fabricado según DIN 1412 C, tolerancia de diámetro h 8
- Larga duración y alta resistencia a la fractura
- Reduce la viruta

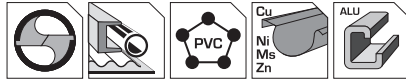

Código	Diá. Ø	L.	N.de pcs	Caja grande	Caja chica
TAC1001163	1/16"	1-9/16"	10	8400	200
TAC1003323	3/32"	2-1/4"	10	8400	200
TAC1001083	1/8"	2-9/16"	10	4200	100
TAC1005323	5/32"	3"	10	4200	100
TAC1011643	11/64"	3-1/8"	10	2100	100
TAC1003163	3/16"	3-3/8"	10	2100	100
TAC1001043	1/4"	4"	10	1100	22
TAC1005163	5/16"	4-5/8"	5	550	50
TAC1003083	3/8"	4-15/16"	5	440	40
TAC1001023	1/2"	5-15/16"	5	240	40

Brocas HSS

INDUSTRIAL

M2

- Torsión hecha en acero de alta velocidad fabricado para Din 338
- Punto de hendidura fabricado según DIN 1412 C, tolerancia de diámetro h 8
- La fuerza de alimentación se reduce hasta en un 50%
- La broca facilita el progreso de la perforación hasta en un 45%
- Larga duración y alta resistencia a la fractura
- Reduce la viruta

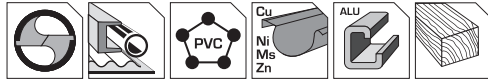

Código	Diá. Ø	Longitud	N.de pcs	Caja grande	Caja chica
TAC1107641	7/64"	2-3/8"	20	1920	
TAC1101081	1/8"	2-7/8"	20	1920	
TAC1109641	9/64"	2-7/8"	20	1920	
TAC1105321	5/32"	3-1/8"	10	800	
TAC1111641	11/64"	3-1/4"	10	800	
TAC1103161	3/16"	3-1/2"	10	800	
TAC1113641	13/64"	3-5/8"	10	800	
TAC1107321	7/32"	3-3/4"	10	800	
TAC1101041	1/4"	4-1/8"	10	350	350
TAC1105161	5/16"	4-1/2"	10	350	350
TAC1103081	3/8"	5"	10	350	350
TAC1107161	7/16"	5-1/2"	10	200	200
TAC1101021	1/2"	6"	10	200	200

Brocas de concreto

INDUSTRIAL



- Resistente a impactos y a doblarse, garantiza una vida útil más larga
- El gran volumen espiral permite en la perforación una extracción de polvo óptima
- Garantiza baja vibración para un trabajo libre de fatiga
- Adecuado para perforar en granito, hormigón, piedra caliza, mampostería

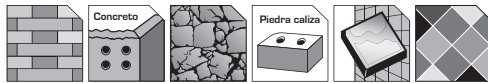

Código	Diá Ø	Longitud	Caja grande	Caja chica
TAC2105321	5/32"	3"	500	250
TAC2103161	3/16"	3 3/8"	300	150
TAC2107321	7/32"	4"	300	150
TAC2105162	5/16"	6"	160	80
TAC2103081	3/8"	4 3/4"	200	100
TAC2103083	3/8"	8"	120	60

BROCA SDS PLUS PARA ROTOMARTILLO

INDUSTRIAL

- Broca resistente a impactos y flexionarse.
- Brocas de carburo de tungsteno fabricadas a alta temperatura para una perforación rápida, precisa y segura
- La espiral de gran volumen permite una eliminación óptima del polvo
- La baja vibración garantiza un trabajo sin fatiga
- Adecuado para perforar en granito, hormigón, mampostería, piedra caliza, piedra natural y artificial, etc.



SDS PLUS



Código	Diá Ø	Longitud	Caja grande
TAC3101042	1/4"	6 1/4"	180
TAC3103084	3/8"	10 1/4"	150
TAC3101023	1/2"	10 1/4"	120

BROCA MAX PLUS PARA ROTOMARTILLO

INDUSTRIAL

- Broca resistente a impactos y flexionarse.
- Brocas de carburo de tungsteno fabricadas a alta temperatura para una perforación rápida, precisa y segura
- La espiral de gran volumen permite una eliminación óptima del polvo
- La baja vibración garantiza un trabajo sin fatiga
- Adecuado para perforar en granito, hormigón, mampostería, piedra caliza, piedra natural y artificial, etc.

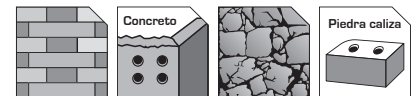

SDS MAX



Código	Diá (mm)	L (mm)	Caja grande
TAC321007	10	260	50
TAC321207	12	260	50
TAC321407	14	260	50
TAC321607	16	260	50
TAC321600	16	340	50
TAC321800	18	340	50
TAC322000	20	340	25
TAC322200	22	340	25
TAC322500	25	340	25

CINSEL SDS PLUS, SDS MAX, HEX

INDUSTRIAL

- Fabricado en acero de cromo molibdeno, para trabajos de demolición y cincelado general en hormigón y mampostería
- Acabado arenado

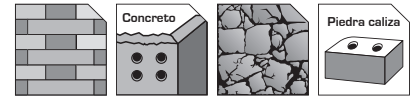

Código	Caña	Ø (mm)	Ancho (mm)	Longitud(mm)	Caja grande	Caja chica
TAC1511141	PLUS	14	Punta	250	100	10
TAC15121411	PLUS	14	20	250	100	10
TAC15121412	PLUS	14	40	250	100	10



Código	Caña	Ø (mm)	Ancho (mm)	Longitud(mm)	Caja grande	Caja chica
TAC1521181	MAX	18	Punta	280	25	1
TAC15221821	MAX	18	25	400	25	1



Código	Caña	Ø (mm)	Ancho (mm)	Longitud(mm)	Compatibilidad	Caja grande	Caja chica
TAC1531301	HEX	30	Punta	410	Demolidora UTH215456	10	1
TAC1532301	HEX	30	40	410	Demolidora UTH215456	10	1
TAC1531282	HEX	28	Punta	530	Demolidora UTH220502	5	1
TAC1532282	HEX	28	35	530	Demolidora UTH220502	5	1

Brocas para azulejos y vidrios

- Punta de carburo de tungsteno de alto grado
- Caña de aleación de acero, endurecido y templado
- Afilado por máquinas de pulido de diamantes
- Única punta de lanza que evita astillado y rompimiento
- El borde del cincel afilado facilita la perforación precisa del agujero

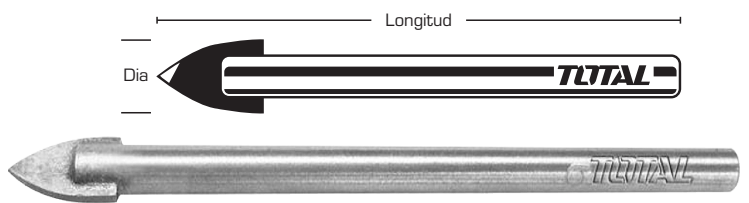
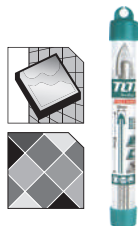

Código	Díámetro	Longitud(mm)	Caja grande	Caja chica
UTACG100601	1/4"	2 - 5/8"	10	1
UTACG100801	5/16"	3"	10	1

Broca de azulejo y vidrio

10x90mm



NEW

Código	Medida (mm)
TACG101012	10x90

100

Broca de azulejo y vidrio

8x83mm



NEW

Código	Medida (mm)
TACG100812	8x83

100

Brocas M2 HSS

INDUSTRIAL



M2

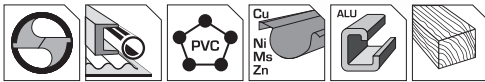

Código	Diá. Ø	Ángulo	N.de pcs	Caja grande
TAC1201322	1/32"	130°	2	1000
TAC1203642	3/64"	130°	2	1000
TAC1201162	1/16"	130°	2	1000
TAC1205642	5/64"	130°	2	1000
TAC1203322	3/32"	130°	2	1000
TAC1201082	1/8"	130°	2	1000
TAC1205321	5/32"	130°	2	1000
TAC1211641	11/64"	130°	1	1000

Código	Diá. Ø	Ángulo	N.de pcs	Caja grande
TAC1203161	3/16"	130°	1	1000
TAC1207321	7/32"	130°	1	1000
TAC1201043	1/4"	130°	1	1000
TAC1205163	5/16"	130°	1	500
TAC1203083	3/8"	130°	1	500
TAC1207161	7/16"	130°	1	500
TAC1201021	1/2"	130°	1	500

Brocas M2 HSS milimétricas

INDUSTRIAL



M2



Código	Diá. Ø	Ángulo	N.de pcs	Caja grande
TAC1200102	1mm	130°	2	1000
TAC1200152	1.5mm	130°	2	1000
TAC1200202	2mm	130°	2	1000
TAC1200252	2.5mm	130°	2	1000
TAC1200302	3mm	130°	2	1000
TAC1200351	3.5mm	130°	1	1000
TAC1200401	4mm	130°	1	1000
TAC1200451	4.5mm	130°	1	1000
TAC1200501	5mm	130°	1	1000
TAC1200551	5.5mm	130°	1	1000
TAC1200601	6mm	130°	1	1000
TAC1200651	6.5mm	130°	1	500

Código	Diá. Ø	Ángulo	N.de pcs	Caja grande
TAC1200701	7mm	130°	1	500
TAC1200751	7.5mm	130°	1	500
TAC1200801	8mm	130°	1	500
TAC1200851	8.5mm	130°	1	500
TAC1200901	9mm	130°	1	500
TAC1200951	9.5mm	130°	1	500
TAC1200101	10mm	130°	1	500
TAC1201051	10.5mm	130°	1	500
TAC1201101	11mm	130°	1	500
TAC1201201	12mm	130°	1	500
TAC1201301	13mm	130°	1	500

Brocas para concreto

INDUSTRIAL

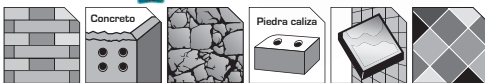

Código	Diá. Ø	Longitud	N.de pcs	Caja grande
TAC210301081	1/8"	3x75mm	2	1000
TAC210405321	5/32"	4x75mm	1	1000
TAC210503161	3/16"	5x85mm	1	1000
TAC215507321	7/32"	5.5x90mm	1	1000
TAC216501041	1/4"	6.5x100mm	1	1000
TAC210805161	5/16"	8x120mm	1	1000
TAC219503081	3/8"	9.5x120mm	1	1000
TAC211107161	7/16"	11x150mm	1	1000
TAC211301021	1/2"	13x150mm	1	1000

Broca de Cobalto M35 HSS para metal

INDUSTRIAL



M35

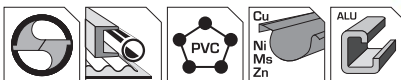

Código	Diá. Ø	N.de pcs	Caja grande
TAC11205322	5/32"	1	500
TAC11203162	3/16"	1	500
TAC11201042	1/4"	1	500
TAC11205162	5/16"	1	220
TAC11203082	3/8"	1	220
TAC11201022	1/2"	1	180
TAC11203201	3.2mm	1	500
TAC11203501	3.5mm	1	500
TAC11204001	4mm	1	500
TAC11204501	4.5mm	1	500
TAC11205001	5.0mm	1	500
TAC11205501	5.5mm	1	500

Código	Diá. Ø	N.de pcs	Caja grande
TAC11206001	6mm	1	500
TAC11206501	6.5mm	1	220
TAC11207501	7.5mm	1	220
TAC11208001	8mm	1	220
TAC11208501	8.5mm	1	220
TAC11209001	9mm	1	220
TAC11210001	10mm	1	220
TAC11211001	11mm	1	180
TAC11212001	12mm	1	180
TAC11214001	14mm	1	180
TAC11216001	16mm	1	180

Broca de Cobalto M35 HSS para metal

2 pzas



M35



INDUSTRIAL

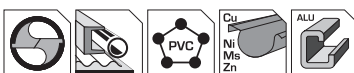

Código	Diá. Ø	N.de pcs	Caja grande
TAC11203322	3/32"	2	500
TAC11202501	2.5mm	2	500
TAC11203001	3mm	2	500

Broca Helicoidal HSS para Metal

Hex 1/4"

INDUSTRIAL



Código	Diá. Ø	Vástago
TAC1140301	3mm	1/4"
TAC1140351	3.5mm	1/4"
TAC1140401	4mm	1/4"
TAC1140421	4.2mm	1/4"
TAC1140451	4.5mm	1/4"
TAC1140501	5mm	1/4"
TAC1140601	6mm	1/4"

Broca Helicoidal HSS para Metal

Hex 1/4"

INDUSTRIAL



Código	Diá. Ø	Vástago
TAC1140751	7.5mm	1/4"



Broca escalonada 4 - 22mm

INDUSTRIAL

4-22mm



Código	Medida (mm)
TAC8242201	Paso: 4-6-8-10-12-14-16-18-20-22mm



Broca escalonada 6 - 35mm

INDUSTRIAL

6-35mm



Código	Medida (mm)
TAC8263501	Paso: 6-10-13-16-19-22-25-29-32-35mm



Broca escalonada 6 - 38mm

INDUSTRIAL

6-38mm



Código	Medida (mm)
TAC8263801	Paso: 6-8-11-14-17-20-23-26-29-32-35-38mm



Broca escalonada 10-20mm

INDUSTRIAL

10-20mm



Código	Medida (mm)
TAC8210201	Paso: 10-11-12-13-14-15-16-17-18-19-20mm



Broca escalonada 10-45mm

INDUSTRIAL

10-45mm



Código	Medida (mm)
TAC8210451	Paso: 10-15-20-25-30-35-40-45mm



Broca avellanadora HSS para metal

INDUSTRIAL



Código	Diá. Ø	Grado	Caja grande
TAC810831	8.3mm	90°	200
TAC811241	12.4mm	90°	200
TAC812051	20.5mm	90°	100

Broca para vidrio y azulejos

Hex 1/4"

INDUSTRIAL



Código	Diá. Ø	Vástago
TACG200812	8x83mm	1/4"
TACG201012	10x90mm	1/4"



Juego de extractor de tornillos

6 pzas

INDUSTRIAL



Código	Medida (mm)
TACSE0061	3~6mm(1#), 6~8mm(2#), 8~11mm(3#), 11~14mm(4#), 14~18mm(5#), 18~25mm(6#)



Conjunto de accesorios 118Pzas

THKTAC01182

INDUSTRIAL

118pzas



Vitrina para brocas

TAKD2688

INDUSTRIAL

NO incluye brocas



- Capacidad para 260 pzas.
- 4 plantas.
- 8 espacios por planta.
- 340mm x 320mm x 430mm



Brocas para vitrina en paquetes

Metal/ Concreto

INDUSTRIAL



- Metal
- M2 HSS
- 135°



- Concreto

Código	Diá. Ø	N.de pcs	Caja grande
TAC1101323	1/32"	10	2000
TAC1103643	3/64"	10	2000
TAC1101163	1/16"	10	2000
TAC1105643	5/64"	10	2000
TAC1103323	3/32"	10	2000
TAC1107643	7/64"	10	2000
TAC1101083	1/8"	10	2000
TAC1109643	9/64"	10	2000
TAC1105323	5/32"	10	2000
TAC1111643	11/64"	10	1000
TAC1103163	3/16"	10	1000
TAC1113643	13/64"	10	1000
TAC1107323	7/32"	10	1000
TAC1115642	15/64"	10	700
TAC1101043	1/4"	10	500
TAC1117643	17/64"	10	500
TAC1109323	9/32"	10	500
TAC1105163	5/16"	10	420
TAC1111322	11/32"	10	420
TAC1103083	3/8"	5	250
TAC1107163	7/16"	5	200
TAC1101023	1/2"	5	200

Código	Diá. Ø	N.de pcs	Caja grande
TAC2103023	1/8"	10	500
TAC2104013	5/32"	10	500
TAC2105013	3/16"	10	500
TAC2155013	7/32"	10	500
TAC2106513	1/4"	10	500
TAC2108013	5/16"	10	400
TAC2109513	3/8"	5	300
TAC2101113	7/16"	5	250
TAC2101313	1/2"	5	250

Juego de brocas para vitrina 260 pzas

TAKD2608M-2

INDUSTRIAL

NO incluye vitrina

- Cantidad de brocas 260 pzas.

Brocas HSS: 103 pzas

20pcs: 1/16", 20pcs 5/64", 10pcs 7/64", 10pcs 5/32", 10pcs 3/16", 10pcs 15/64", 5pcs 17/64", 5pcs 5/16", 5pcs 11/32", 5pcs 25/64", 3pcs 15/32"

M2 HSS: 58 pzas

10pcs: 7/64", 10pcs 5/32", 10pcs 3/16", 10pcs 15/64", 5pcs 5/16", 5pcs 11/32", 5pcs 25/64", 3pcs 15/32"

Mampostería: 62 pzas

10pcs: 5/32"x3", 1/4"x4", 1/4"x6", 5/16"x4-3/4", 6pcs: 3/8"x4-3/4", 3/8"x6" 5pcs: 1/2"x6", 1/2"x8"

SDS PLUS: 37 pzas

5pcs: 1/4"x6-1/4", 5/16"x6-1/4", 3/8"x6-1/4", 5/16"x8-1/4", 3/8"x8-1/4", 1/2"x8-1/4", 4pcs 9/16"x8-1/4", 3pcs 5/8"x8-1/4"

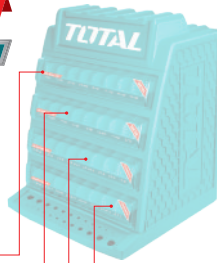

Juego de puntas de destornillador

TACSDDL24502

45pzas

INDUSTRIAL

Impacto



Juego de puntas de destornillador

TACSDDL24501

45pzas

INDUSTRIAL

Torsión



Juego de brocas para taladro de impacto

TACSDDL30901

9pzas

INDUSTRIAL

SDS PLUS

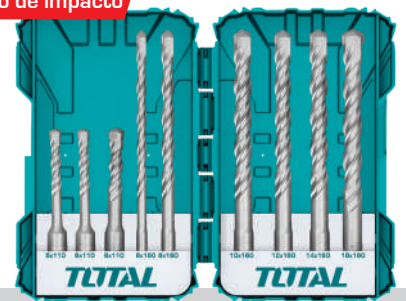

<p>Juego de brocas para concreto</p> <p>TACSDL31101</p> <p>11 pzas INDUSTRIAL</p> <p>12</p>	<p>Juego de brocas planas para madera</p> <p>TACSDL1201</p> <p>12 pzas INDUSTRIAL</p> <p>12</p>								
<p>Juego de brocas HSS</p> <p>TACSDL51501</p> <p>15 pzas INDUSTRIAL</p> <p>12</p>	<p>Juego de brocas HSS M2</p> <p>TACSDL51502</p> <p>15 pzas INDUSTRIAL M2</p> <p>12</p>								
<p>Juego de brocas para metal, concreto y madera</p> <p>TACSDL11601</p> <p>16 pzas INDUSTRIAL</p> <p>12</p>	<p>Juego de brocas y destornilladores</p> <p>TACSDL12201</p> <p>22 pzas INDUSTRIAL</p> <p>12</p>								
<p>Juego de brocas helicoidales HSS</p> <p>6 pzas INDUSTRIAL</p> <p> </p> <table border="1"> <thead> <tr> <th>Código</th> <th>Medida (mm)</th> </tr> </thead> <tbody> <tr> <td>UTACSD0066</td> <td>5/64", 7/64", 5/32", 3/16", 7/32", 5/16"</td> </tr> </tbody> </table> <p>24 2</p>	Código	Medida (mm)	UTACSD0066	5/64", 7/64", 5/32", 3/16", 7/32", 5/16"	<p>Juego de brocas para mampostería</p> <p>5 pzas INDUSTRIAL</p> <p> </p> <table border="1"> <thead> <tr> <th>Código</th> <th>Medida (mm)</th> </tr> </thead> <tbody> <tr> <td>UTACSD5051</td> <td>5/32"x3-3/8", 3/16"x4", 1/4"x4-3/4", 5/16"x4-3/4", 3/8"x4-3/4"</td> </tr> </tbody> </table> <p>24 4</p>	Código	Medida (mm)	UTACSD5051	5/32"x3-3/8", 3/16"x4", 1/4"x4-3/4", 5/16"x4-3/4", 3/8"x4-3/4"
Código	Medida (mm)								
UTACSD0066	5/64", 7/64", 5/32", 3/16", 7/32", 5/16"								
Código	Medida (mm)								
UTACSD5051	5/32"x3-3/8", 3/16"x4", 1/4"x4-3/4", 5/16"x4-3/4", 3/8"x4-3/4"								
<p>Brocas SDS PLUS para taladro de impacto</p> <p>5 pzas INDUSTRIAL</p> <p> </p> <table border="1"> <thead> <tr> <th>Código</th> <th>Medida (mm)</th> </tr> </thead> <tbody> <tr> <td>UTAC190501</td> <td>6x110, 8x110, 8x160, 10x160, 12x160</td> </tr> </tbody> </table> <p>30</p>	Código	Medida (mm)	UTAC190501	6x110, 8x110, 8x160, 10x160, 12x160	<p>Juego de brocas helicoidales HSS</p> <p>6 pzas INDUSTRIAL</p> <p> </p> <table border="1"> <thead> <tr> <th>Código</th> <th>Medida (mm)</th> </tr> </thead> <tbody> <tr> <td>UTACSD0605</td> <td>5/64", 7/64", 5/32", 3/16", 7/32", 5/16"</td> </tr> </tbody> </table> <p>24 1</p>	Código	Medida (mm)	UTACSD0605	5/64", 7/64", 5/32", 3/16", 7/32", 5/16"
Código	Medida (mm)								
UTAC190501	6x110, 8x110, 8x160, 10x160, 12x160								
Código	Medida (mm)								
UTACSD0605	5/64", 7/64", 5/32", 3/16", 7/32", 5/16"								

Brocas para albañilería

5 pzas

INDUSTRIAL

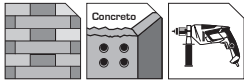

24

Código	Medida (mm)
UTACSD5055	5/32"x3-3/8", 3/16"x4", 1/4"x4-3/4", 5/16"x4-3/4", 3/8"x4-3/4"

Juego de brocas y destornilladores

16 pzas

INDUSTRIAL

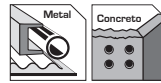

40 2

Código	Medida (mm)
UTACSD3165	Metal: 5/64", 7/64", 1/8", 5/32", 3/16", 7/32 Concreto: 3/16", 7/32", 1/4", 5/16" Destornilladores: SL4.5, SL5.5, PH1, PH2, PZ1, PZ2

Destornilladores de impacto

10 pzas

INDUSTRIAL

- Fabricado en acero industrial S2 de alta dureza y torque
- Zona de choque más grande optimizada, reduce las roturas de la punta
- Casquillo de alta visibilidad
- Punta estrella negra magnética

Impacto



100

Código	N. de pzas	Diá. Ø	Longitud
TACIM16PH223	10	PH2	50mm

Destornilladores de impacto

10 pzas

INDUSTRIAL

- Fabricado en acero industrial S2 de alta dureza y torque
- Zona de choque más grande optimizada, reduce las roturas de la punta
- Casquillo de alta visibilidad
- Punta estrella negra magnética

Impacto



100

Código	N. de pzas	Diá. Ø	Longitud
TACIM16PH233	10	PH2+PH2	65mm

Destornilladores de impacto

10 pzas

INDUSTRIAL

- Fabricado en acero industrial S2 de alta dureza y torque
- Zona de choque más grande optimizada, reduce las roturas de la punta
- Casquillo de alta visibilidad
- Punta estrella y plana negra magnética

Impacto



100

Código	N. de pzas	Diá. Ø	Longitud
TACIM16HL133	10	PH2+SL6.0x1.0	65mm

Destornilladores de impacto

10 pzas

INDUSTRIAL

- Fabricado en acero industrial S2 de alta dureza y torque
- Zona de choque más grande optimizada, reduce las roturas de la punta
- Casquillo de alta visibilidad
- Punta estrella negra magnética

Impacto



50

Código	N. de pzas	Diá. Ø	Longitud
TACIM16PH263	10	PH2	150mm

Destornilladores de impacto

10 pzas

INDUSTRIAL

- Fabricado en acero industrial S2 de alta dureza y torque
- Zona de choque más grande optimizada, reduce las roturas de la punta
- Punta estrella negra magnética

Impacto



50

Código	N. de pzas	Diá. Ø	Longitud
TACIM16PH283	10	PH2	200mm
TACIM16PH2103	10	PH2	250mm

Juego de puntas de destornillador

30 pzas

INDUSTRIAL



40 4

Código	Medida (mm)
TACSD10306	PZ0-1-2-3, PH0-1-2-3-4, SL3-4-5-6, T10-15-20-25-27-30-40, H3-4-5-6, S1-2-3, 1 destornillador

Juego de puntas de destornillador

30 pzas

INDUSTRIAL



Impacto



40 4

Código	Medida (mm)
TACSD18306	PZ0-1-2-3, PH0-1-2-3-4, SL3-4-5-6, T10-15-20-25-27-30-40, H3-4-5-6, S1-2-3, 1 destornillador

Destornilladores

10 pzas

INDUSTRIAL

- Fabricado en acero industrial S2 de alta dureza y torque
- Hecho por maquinaria CNC alemana, agarre preciso del tornillo
- Niquelado magnético
- Punta de estrella



Código	N. de pzas	Diámetro	Longitud
TAC16PH223	10	PH2	50mm / 2"

100 25

Destornilladores

10 pzas

INDUSTRIAL



S2

• Dos puntas



Placa de níquel



100 4

Código	Diámetro	Largo
TAC16PH233	PH2xPH2	65mm(2.5")

Destornilladores

10 pzas

INDUSTRIAL



S2

• Dos puntas



Placa de níquel



100 25

Código	Diámetro	Largo
TAC16HL133	PH2xSL6.0mm	65mm(2.5")

Punta de destornillador

2 pzas

INDUSTRIAL

NEW



S2

• Punta magnética



Placa de níquel



800

Código	Diámetro	Largo
TAC16PH214	PH2	25mm

Destornilladores

2 pzas

INDUSTRIAL

NEW



S2

• Punta magnética



Placa de níquel



800

Código	Diámetro	Largo
TAC16SL614	SL6x1.0mm	25mm

Punta de destornillador

2 pzas

INDUSTRIAL

NEW



S2

• Punta magnética



Placa de níquel



400

Código	Diámetro	Largo
TAC16PH224	PH2	50mm

Punta de destornillador

2 pzas

INDUSTRIAL

NEW



S2

• Punta magnética



Placa de níquel



400

Código	Diámetro	Largo
TAC16SL624	SL6x1.0mm	50mm

Punta de destornillador

2 pzas

INDUSTRIAL

NEW



S2

• Doble punta



Placa de níquel



300

Código	Diámetro	Largo
TAC16PH234	PH2+PH2	65mm

Punta de destornillador

2 pzas

INDUSTRIAL

NEW



S2

• Doble punta



Placa de níquel



300

Código	Diámetro	Largo
TAC16HL234	PH2+SL6x1.0mm	65mm

Punta de destornillador

1 pzas

INDUSTRIAL

NEW

• Punta magnética



S2



Código	Diá. Ø	Longitud	Caja G.
TAC16PH274	PH2	100mm	600
TAC16PH264	PH2	150mm	400
TAC16PH284	PH2	200mm	300
TAC16PH2104	PH2	250mm	200

Porta puntas de destornillador

80 mm

NEW



Código	Medida(mm)
TAC463801	80

400

Porta puntas de destornillador

60 mm

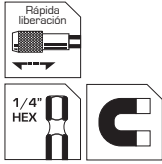

400

Código	Medida(mm)
TAC462602	60

Porta puntas de destornillador

60 mm

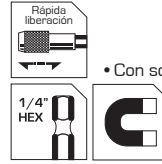

400

Código	Medida(mm)
TAC464601	60

Porta puntas de destornillador 2pcs

60 mm

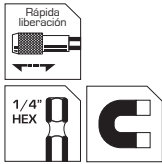

100 25

Código	Medida(mm)
TAC462601	60

Juego de destornilladores

9 pzas

- Fabricado en acero industrial S2
- Incluye adaptador

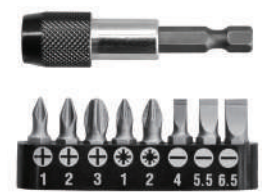
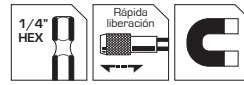

100 25

Código	Medida (mm)
TACSD3091	PH1,PH2,PH3,SL4.0,SL5.5,SL6.5,PZ1,PZ2

Juego magnético de tuerca hexagonal

3 pzas



100 25

Código	Medida	Largo(mm)
UTAC270631	1/4"	65
UTAC270831	5/16"	65
UTAC271031	3/8"	65
UTAC271331	1/2"	65

Porta puntas de destornillador 2pcs

60 mm

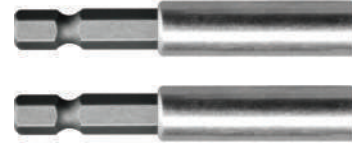
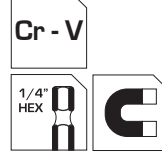

100 25

Código	Medida(mm)
TAC461601	60

Set de adaptadores para sockets

1/4" - 3/8" - 1/2"

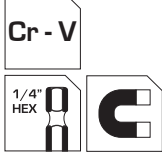

100 25

Código	Medida(mm)
TAC273651	1/4", 3/8", 1/2"

Brocas Forstner

- Adecuado para madera suave, dura y madera chapeada
- Broca de precisión con espuelas de corte principales y laterales, y punta central corta
- La cuchilla de carburo de tungsteno de alta calidad brinda más mordida al material
- Cumple con altos requisitos en cuanto a calidad de corte



Código	Diámetro(mm)	Longitud(mm)	Caña(mm)
TAC180251	25	85	10
TAC180321	32	85	10

Mandril para sierra de orificio

- Broca guía HSS
- Vástago hexagonal para mayor torque

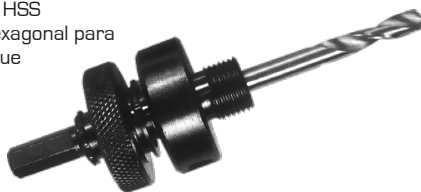

60 1

Código	Medida de caña	Broca	Orificio adaptable
TAC4201	3/8"	5/8"-18UNF	14mm a 30mm

Vástago guía para brocas

- 1 pzas placa de aluminio
- 1 pzas taladro piloto
- Adecuado para sierra de agujero de carburo $\Phi 33$, $\Phi 43$, $\Phi 53$, $\Phi 63$, $\Phi 67$, $\Phi 73$, $\Phi 83$



50

Código	Min. RPM	Max. RPM
TAC4203	800	1600

Mandril para sierra de orificio

- Broca guía HSS
- Vástago hexagonal para mayor torque



120

Código	Medida de caña	Broca	Orificio adaptable
TAC4206	7/16"	1/2"x20UNF	14mm a 30mm

Mandril para sierra de orificio

- SDS plus
- Broca guía HSS
- Vástago hexagonal para mayor torque



SDS+
1/2"x20UNF



120

Código	Medida de caña	Broca	Orificio adaptable
TAC4205	1/2"	1/2"x20UNF	14mm a 30mm

Mandril para sierra de orificio

- SDS plus
- Broca guía HSS
- Vástago hexagonal para mayor torque



SDS+
5/8"x18UNF



60

Código	Medida de caña	Broca	Orificio adaptable
TAC4204	5/8"	5/8"x18UNF	32mm a 200mm

Set de 3 piezas sierra de orificio

3 pzas



60

Código
TACSH1031

Juego de puntas de router

24 pzas

- Vástago 12mm



10

Código	N. de piezas
TACSR02412	24

Juego de puntas de router

24 pzas

- Vástago 1/4"



10

Código	N. de piezas
TACSR0240104	24

Juego de puntas de router

24 pzas

- Vástago 1/2"



10

Código	N. de piezas
TACSR0240102	24

Puntas mixtas para router

12 pzas

1/4" - 1/2"

Compatible con router UTR11122

Código	Diámetro
TACSR0104121	1/4" (6mm)
TACSR0102121	1/2" (12mm)



20

Cuchilla HSS, cepillo de madera

82x5.5x1.2mm

HSS

x2



300 15

Código	Medida(mm)
TAC618201	82x5.5x1.2

Cuchillas para cepillo de madera

82x29x3mm

HSS

x2



Compatible con cepillo THT9391

100 20

Código	Medida(mm)
TAC618202	82x29x3

Juego de sierras de orificio

7 pzas



Código	Medida (mm)	Alto
TACSH3071	26,32,38,45,50,56,63	50mm (2")



Brocas de carburo sacabocado

7 pzas



- Para piedras y cerámicas
- Material: YG8C + A3



Código	Medida
TAC440331	33 mm
TAC440431	43 mm
TAC440531	53 mm
TAC440671	67 mm
TAC440731	73 mm
TAC440831	83 mm

Juego de brocas de copa para concreto

INDUSTRIAL

- Cortador super resistente, para las aplicaciones más difíciles.
- Cuerpo robusto y broca espiral endurecida para una perforación extremadamente rápida.
- Los dientes de carburo de tungsteno en la broca garantizan una larga vida útil.
- Adecuado para hormigón, mampostería, piedra caliza.

Código	TAC430501	TAC430651	TAC430801
Diámetro	50mm	65mm	80mm
Longitud de trabajo	50mm	50mm	50mm
Cantidad de cortadores	5	8	8
Tamaño de rosca	M22x2	M22x2	M22x2
Broca	8x110mm	8x110mm	8x110mm
Adaptador PLUS	110mm	110mm	110mm



Sierras de orificio bi-metal

INDUSTRIAL

- Borde bi-metal de acero M-3 HSS para alta velocidad
- Aleación de acero soldado a la parte posterior para cortes de trabajo pesado
- Dientes variables 4/6 TPI
- Corta tubos de acero inoxidable y otros materiales, madera con clavos, pisos de madera dura, madera contrachapada y plásticos, etc.

Código	Diá. Ø	Profundidad	Código	Diá. Ø	Profundidad
TAC410161	16mm	38mm	TAC410381	38mm	38mm
TAC410191	19mm	38mm	TAC410461	46mm	38mm
TAC410221	22mm	38mm	TAC410511	51mm	38mm
TAC410251	25mm	38mm	TAC410641	64mm	38mm
TAC410321	32mm	38mm	TAC410761	76mm	38mm

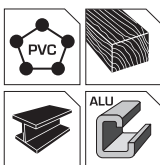

Brocas de carburo sacabocado

7 pzas



- 1 pzas placa de aluminio
- 1 pzas taladro piloto
- Para piedras y cerámicas

Código	Medida (mm)
TACSH2071	33,53,67,73,83



Juego de sierras de orificio

7 pzas

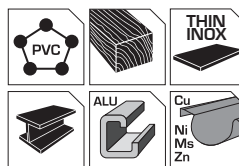

Código	Medida (mm)
TACSH1071	19,22,29,32,35



Maletín brocas cilíndricas Bi-Metal

12 pzas

INDUSTRIAL



Medidas: 20mm, 22mm, 25mm, 29mm, 32mm, 35mm, 38mm, 44mm, 48mm, 50mm, 2pcs de adaptadores



Código	N. de piezas
TACSH1121	12



Brocas para perforar concreto

82mm/102mm

INDUSTRIAL

- Brocas para perforar concreto con acero reforzado y baldosas.
- Segmentos soldados por láser.
- Especial para cortar hormigón con armadura.



M22x2.5

Código	Diámetro	Largo	Adaptador
TAC2810821	82mm (3")	450mm	M22x2.5
TAC2811021	102mm (4")	450mm	M22x2.5

Adaptador para brocas de copa

INDUSTRIAL



Compatible con broca TAC430501, TAC430651, TAC430801

Código	Vástago	Rosca	Largo	Broca
TAC43A13501	PLUS	M22x2	350mm	8x110mm

30

Cuchilla para caladora

5 pzas

INDUSTRIAL



- Hecho de acero al carbono de alta calidad
- Cuchilla para **madera** (4-50mm), tableros de fibra, plywood



Código	Especificación
TAC51111C	5 Pcs para madera, 8TPI



250

Cuchilla para caladora

5 pzas

INDUSTRIAL



- Hecho de acero al carbono de alta calidad
- Cuchilla para **madera** (10-45mm), tableros de fibra, plywood



Código	Especificación
TAC51101D	5 Pcs para madera, 6TPI



250

Cuchilla para caladora

5 pzas

INDUSTRIAL



- Hecho de acero al carbono de alta calidad
- Cuchilla para **metal** de espesor medio (2.5 - 6mm)

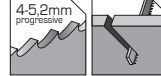

Código	Especificación
TAC51118B	5 Pcs para metal, 12TPI



250

Cuchilla mixtas

5 pzas

INDUSTRIAL



Código	Especificación
TAC51051	2 Pcs para madera, 8TPI 2 Pcs para metal, 12TPI 1 Pcs para aluminio, 8TPI



250

Cuchilla mixtas

8 pzas

INDUSTRIAL



Código	Especificación
TACSD7386	1 Pza para madera JBT101 4 Pzas corte rápido de madera JBT111C 2 Pzas para metal JBT118B 1 pza para aluminio 127D



Hojas de sierra recíproca para madera

2 pzas

INDUSTRIAL

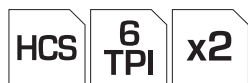

Corte rápido
Tallo de 1/2"

Código	Medida(mm)
TAC52644D	150X19X1.25



100

Hojas de sierra recíproca para metal

2 pzas

INDUSTRIAL

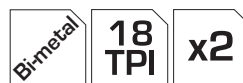

Corte rápido en metal o inoxidable
de 1.5 - 4 mm de espesor
Tallo de 1/2"

Código	Medida(mm)
TAC52922EF	150X19X0.9



100

Sierra de corte TCT para madera

2 pzas

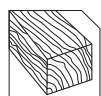

SUPER SELECT



Código	Diámetro	Max.RPM	Dientes	Mandril(mm)
TAC231410	185mm	8200	30T	20
TAC2316252	235mm	6500	40T	30

Disco de corte diamante

INDUSTRIAL

- Uso universal: cerámica, azulejo, mármol, ladrillo.
- Prohibido su uso para ladrillo vitrificado (nano vidrio).

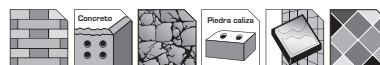

Código	Tipo	Medida	Ancho	Aplicación
TAC2121151	Univ. liso	115x22mm	7.5mm	Corte en húmedo
TAC2131151	Turbo	115x22mm	10mm	Corte seco y húmedo
TAC2131801	Turbo	180x22mm	10mm	Corte seco y húmedo

Cuchillas para caladora

5 pzas

INDUSTRIAL



- Hecho de acero al carbono de alta calidad
- Cuchilla para **madera** (4-50mm), tableros de fibra, plywood



Código	Especificación
TJSBT111C	5 Pzas para madera, 74mm, 8TPI



Cuchillas para caladora

5 pzas

INDUSTRIAL



- Hecho de acero al carbono de alta calidad
- Cuchilla para corte rápido en **madera**



Código	Especificación
TAC51144D	5 Pzas para madera, 74mm, 6TPI



Cuchillas para caladora

5 pzas

INDUSTRIAL



- Hecho de acero al carbono de alta calidad
- Cuchilla para **madera**



Código	Especificación
TAC51101B	5 Pzas para madera, 74mm, 10TPI



Cuchilla para caladora

5 pzas

INDUSTRIAL



- Hecho de acero al carbono de alta calidad
- Cuchilla para **metal**
- Distancia entre dientes: 1.9-2.3mm



Código	Especificación
TJSBT118B	5 Pzas para metal, 50mm



Cuchillas para caladora

5 pzas

INDUSTRIAL



- Hecho de acero al carbono de alta calidad
- Cuchilla para **metal**

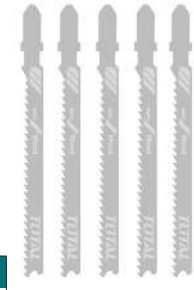

Código	Especificación
TAC51118A	5 Pzas para metal, 50mm, 21TPI



Cuchillas para caladora

15 pzas

INDUSTRIAL



- Hecho de acero al carbono de alta calidad
- Cuchilla para **madera**
- Tipo T111C



Código	Especificación
TAC15111C	15 Pzas para madera, 74mm, 8TPI



Cuchillas para caladora

15 pzas

INDUSTRIAL



- Hecho de acero al carbono de alta calidad



Código	Especificación
TAC1501	15 Pzas



Hojas de sierra recíproca para madera

5 pzas

INDUSTRIAL



Código	Medida(mm)
TRSB611D	150X19X1.2



Set de hojas de sierra recíproca

10 pzas

INDUSTRIAL



Código	Medida(mm)
TRSB1001	3 piezas 150mm 6 dientes, 2 piezas 150mm 18 dientes, 3 piezas 150mm, 3 piezas 10 dientes, 2 piezas 200 mm 6 dientes.



Broca Sacabocado TCT para acero inoxidable

7 pzas



- Profundidad de trabajo: 26 mm
- Triángulo shank, tamaño: 10mm
- 1 pcs 6mm Core bit

Código	Medida (mm)
TAC48201	20
TAC48221	22
TAC48251	25
TAC48321	32
TAC48351	35



Disco de corte diamante

Diseño de embalaje patentado

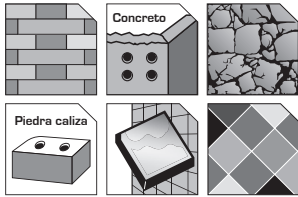

Código	Tipo	Medida(mm)	Velocidad Max. (min⁻¹)	(m/s)	Aplicación	Caja grande	Caja chica
TAC2111153	Univ, Segmentado	115 (4 1/2") x22.2	13200	80	Corte húmedo y en seco	100	50
TAC2111253	Univ, Segmentado	125 (5") x22.2	12200	80	Corte húmedo y en seco	60	30
TAC2111803	Univ, Segmentado	180 (7") x22.2	8500	80	Corte húmedo y en seco	40	20
TAC2112303	Univ, Segmentado	230 (9") x22.2	6600	80	Corte húmedo y en seco	20	10
TAC2121153	Universal	115 (4 1/2") x 22.2	13000	80	Corte húmedo	100	50
TAC2121803	Universal	180 (7") x 22.2	8700	80	Corte húmedo	40	20
TAC2131153	Universal, Turbo	115 (4 1/2") x 22.2	13000	80	Corte húmedo y en seco	100	50
TAC2131803	Universal, Turbo	180 (7") x 22.2	8700	80	Corte húmedo y en seco	40	20
TAC2132303	Universal, Turbo	230 (9") x 22.2	6600	80	Corte húmedo y en seco	20	10

Disco de sierra TCT para aluminio

INDUSTRIAL

Diseño de embalaje patentado

- Disco de carburo de tungsteno de alto grado, con dientes más afilados para un mejor corte
- Cuchilla para corte rápido longitudinal y transversal en el aluminio
- Menor vibración, amortigua el ruido y reduce la producción de calor

Aplicación: Corte en aluminio, sierra de inglete



Código	Diámetro	Max.RPM	Dientes	Mandril(mm)	Anillo reductor(mm)	Caja grande	Caja chica
TAC233523	210mm, 8 1/4"	7200	60T	30	25.4;16	50	25
TAC233728	254mm, 10"	6000	80T	30	25.4;16	25	5
TAC2337210	254mm, 10"	6000	100T	30	25.4;16	25	5
TAC2339212	305mm, 12"	5000	120T	30	25.4;16	10	1

Sierra de corte TCT para madera

INDUSTRIAL

Diseño de embalaje patentado

- Disco de carburo de tungsteno de alto grado, con dientes más afilados para un mejor corte
- Cuchilla para corte rápido longitudinal en todo tipo de madera
- Menor vibración, amortigua el ruido y reduce la producción de calor

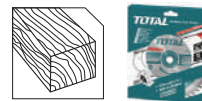

Código	Diámetro	Max.RPM	Dientes	Mandril(mm)	Anillo reductor(mm)	Caja grande	Caja chica
TAC231255	115mm, 4 1/2"	13300	40T	22.2	16	100	50
TAC232241	140mm, 5 1/2"	10920	24T	25.4	16	-	-
TAC2323111	165mm, 6 1/2"	-	24T	20	-	-	50
TAC231415	185mm, 7 1/4"	8200	40T	20	16	50	25
TAC231413	185mm, 7 1/4"	8200	60T	20	16	50	25
TAC231521	210mm, 8 1/4"	7200	24T	30	25.4;16	50	25
TAC231725	254mm, 10"	6000	40T	30	25.4;16	25	5
TAC231723	254mm, 10"	6000	60T	30	25.4;16	25	5
TAC231923	305mm, 12"	5000	60T	30	25.4;16	10	1

Disco de corte diamante 2 pzas

2 pzas



Código	Medida(mm)	Ancho(mm)
TAC21111532	115x22	7

60

Disco de corte diamante 3 pzas

3 pzas



Código	Medida(mm)	Ancho(mm)
TAC21123033	230x22	7

10

Disco de diamante 1 pzas

1 pzas

INDUSTRIAL

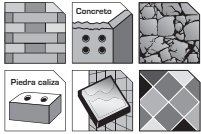

Corte seco



100

Código	Medida(mm)	Ancho(mm)
TAC111254	125x22.2	7.5

Disco de diamante 1 pzas

1 pzas

INDUSTRIAL

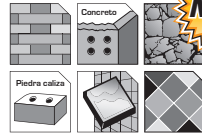

Corte seco



Código	Medida	Corte	Caja
TAC2111151	4 1/2"	12-20mm	100
TAC2111801	7"	12-20mm	40

Disco de diamante ultrafino

1 pzas



INDUSTRIAL



Corte húmedo y seco

100

Código	Medida	Ancho(mm)
TAC2181151HT	4 1/2"	0.8

Disco de diamante ultrafino

1 pzas

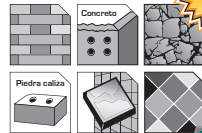

INDUSTRIAL



Corte húmedo y seco

40

Código	Medida	Ancho(mm)
TAC2181801HT	7"	0.8

Disco diamante ultrafino

INDUSTRIAL

- Uso universal: cerámica, azulejo, mármol, ladrillo.
- Prohibido su uso para ladrillo vitrificado (nano vidrio).

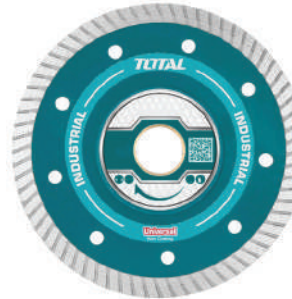

Código	Tipo	Medida(mm)	Velocidad Max. (min ⁻¹)	(m/s)	Aplicación	Caja grande	Caja chica
TAC2131051HT	Universal	105x20 (4"x25/32")	15300	80	Corte húmedo	100	2
TAC2131151HT	Universal	115x22.2 (4 1/2"x7/8")	13200	80	Corte húmedo	100	2
TAC2131801HT	Universal	180x22.2 (7"x7/8")	8500	80	Corte húmedo	40	2
TAC2132301HT	Universal	230x22.2 (9"x7/8")	6600	80	Corte húmedo	20	

Disco diamante ultrafino

- Uso universal: cerámica, azulejo.
- Prohibido su uso para ladrillo vitrificado (nano vidrio).

Para azulejos



Código	Diámetro (mm)	Ancho	Aplicación
TAC2131153HT	115 (4 1/2") x22	8mm	Corte en húmedo
TAC2131803HT	180 (7") x22	8mm	Corte en húmedo

Disco de concreto turbo segmentado

INDUSTRIAL

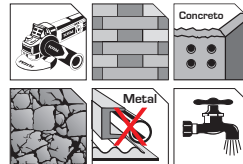

Código	Medida(mm)	Ancho(mm)
TAC2411151	115x22.2	20

20

Rueda para moler de doble filo

INDUSTRIAL

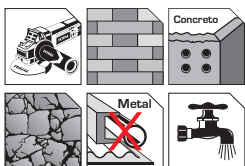

Código	Ø (mm)	Hojas
TAC2421151	115 x 22.2 (7/8")	18

20

Discos de corte para metal cóncavo

- Adecuado para acero, hierro fundido y chapa de acero.



Código	Diá(mm)	Espesor(mm)	Hueco
TAC22111511	115	1.2	22.2mm

400

Discos de corte y desbaste para metal plano

10 pzas

Diseño de embalaje patentado



- Para trabajar piezas de metal, piedra y acero inox. y más
- Proporciona un corte limpio y veloz el cual reduce tiempo de trabajo
- Posee capas de fibra de vidrio que aseguran confiabilidad, seguridad y larga vida útil.

Disco abrasivo para corte de metal

Código	Diá(mm)	Espesor(mm)	Hueco	Piezas por lata
TAC2211155	115	1.2	22.2mm	10



Disco abrasivo para corte de metal

Código	Diá (mm)	Espesor(mm)	Hueco	Caja
TAC2211151	115	1.2	22.2mm	400
TAC2211153	115	1.6	22.2mm	400
TAC2211253	125	1.2	22.2mm	400
TAC2211802	180	1.6	22.2mm	200
TAC2211801	180	3.0	22.2mm	100
TAC2212303	230	1.9	22.2mm	50
TAC2212301	230	3.0	22.2mm	50
TAC2213551	355	3.0	25.4mm	25

Disco abrasivo para desbaste de metal

Código	Diá (mm)	Espesor(mm)	Hueco	Caja
TAC2231151	115	6.0	22.2mm	100
TAC2231251	125	6.0	22.2mm	100
TAC2231801	180	6.0	22.2mm	50
TAC2232301	230	6.0	22.2mm	25

Juego discos de corte para metal plano

50 pzas

- Para metal y acero inoxidable.
- Disco plano.



SUPER SELECT



Código	Diá(mm)	Espesor(mm)	Hueco
TAC22111550	115	1.2	22.2mm



Disco corte de metal y acero inoxidable

1 pza

- Para metal y acero inoxidable.
- Disco cóncavo.
- Hueco de 22.2mm



NEW



Cóncavo



Código	Diá(mm)	Espesor(mm)
TAC2121152	115	1.2
TAC2161802	180	1.6
TAC2192302	230	1.9

Flapdisc de Zirconio

- Adecuado para acero inoxidable.

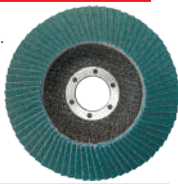

Código	Diámetro (mm)	N. de grano
TAC641151	115 (4 1/2")	P40
TAC641152	115 (4 1/2")	P60
TAC641153	115 (4 1/2")	P80



Disco de lija traslapado

- Adecuado para acero, hierro fundido y chapa de acero.



Código	Diámetro (mm)	N. de grano
TAC631151	115 (4 1/2")	P40
TAC631152	115 (4 1/2")	P60
TAC631153	115 (4 1/2")	P80



Disco abrasivo para esmeril

INDUSTRIAL



Código	Medida (mm)	Grano	Compatible
TAC25150361	150x12.7x16	36	UTBG15015
TAC25150801	150x12.7x16	80	UTBG15015
TAC25200361	200x16x20	36	UTBG35020
TBG35020-SP-G.W80	200x16x20	80	UTBG35020



Disco de tira de polietileno

- Especialmente utilizado para la eliminación de óxido y pintura.



NEW

Código	Diámetro (mm)
TAC651151	115 (4 1/2")



Disco de esponja

- Para pulir acero inox, madera, vidrio, mármol, autos, cemento.



NEW

Código	Diámetro (mm)
TAC661151	115 (4 1/2")



Disco de lana felpa

- Para pulir acero inox, madera, vidrio, mármol, autos, cemento.



NEW

Código	Diámetro (mm)
TAC671151	115 (4 1/2")



Disco de alambre enroscado

INDUSTRIAL

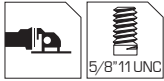

5/8"11 UNC



Código	Ø (mm)	Diámetro rosca	Caja grande	Caja chica
UTAC32031	75 (3")	5/8" 11 UNC	80	10
UTAC32041	100(4")	5/8" 11 UNC	60	10

Disco abrasivo para esmeril

INDUSTRIAL



Código	Medida (mm)	Grano
TAC1506023	150x12.7x16	36
TAC1506027	150x12.7x20	60
TAC2008017	200x16x20	80
TAC2006027	200x16x25	60

Cepillos de limpieza de cerdas duras

2 pzas

INDUSTRIAL



Código	Medida
TACH1235	2", 3.5"



Cepillos de limpieza de cerdas duras

2 pzas

INDUSTRIAL



Código	Medida
TACM2335	3", 3.5"



Cepillo de limpieza de cerdas duras

6"

INDUSTRIAL

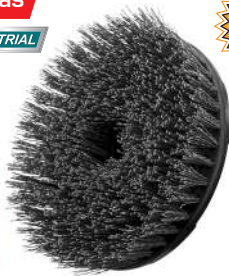

Código	Medida
TACH0651	6"



Set de limpieza de cambio rápido

3 pzas

INDUSTRIAL



Código	Medida
TAC35351	3.5"



Cepillo de cerdas abrasivas con extensión

2 pzas

INDUSTRIAL



Código
TACH0301



Disco de alambre enroscado

INDUSTRIAL

• Baja vibración



VIDA ÚTIL X3



Código	Ø (mm)	Diámetro rosca	Caja grande
UTAC32035	75 (3")	5/8" 11 UNC	40
UTAC32045	100(4")	5/8" 11 UNC	30

Disco de alambre

INDUSTRIAL



5/8"11 UNC



Código	Ø (mm)	Diámetro rosca	Caja grande	Caja chica
UTAC31031	75 (3")	5/8" 11 UNC	80	10
UTAC31041	100(4")	5/8" 11 UNC	60	10

Disco de alambre

INDUSTRIAL

• Baja vibración



VIDA ÚTIL X3



Código	Ø (mm)	Diámetro rosca	Caja grande
UTAC31035	75 (3")	5/8" 11 UNC	40
UTAC31045	100(4")	5/8" 11 UNC	30

Disco de alambre

INDUSTRIAL



Código	Ø (mm)	Diámetro de Caña	Caja grande	Caja chica
TAC33021	50(2")	6.35mm (1/4")	144	12
TAC33031	75(3")	6.35mm (1/4")	120	12

Cepillo de alambre

270mm

INDUSTRIAL

NEW



Código	Medida
TAC3804051	270mm

120

Cepillo de alambre de acero

340mm

INDUSTRIAL

NEW



Código	Medida
TAC38051	340mm

72

Cepillo de alambre de latón

260mm

INDUSTRIAL

NEW



Código	Medida
TAC38061	260mm

72

Cepillos de alambre 7 pzas

- Aplicar en: cepillado, desbarbado, afilado de bordes, desincrustado / decapado de pintura, costuras de soldadura.



NEW

Código	Diá. alambre
TAC310071	0.3mm

36

Juego cepillos de alambre 3 pzas

INDUSTRIAL



NEW



Código
TAC310031

72

Cepillo circular para taladro

INDUSTRIAL



Código	Ø (mm)	Diámetro de Caña	Caja grande	Caja chica
TAC34021	50(2")	6.35mm (1/4")	240	12
TAC34031	75(3")	6.35mm (1/4")	144	12
TAC34041	100(4")	6.35mm (1/4")	100	12

Escobilla de nylon

INDUSTRIAL

- Diámetro de nylon: 1.3 - 1.5mm



Código	Ø (mm)	Diámetro de Caña
TAC33025	50	6.3mm
TAC33035	75	6.3mm

120

Escobilla de nylon

INDUSTRIAL

- Diámetro de nylon: 1.3 - 1.5mm



Código	Ø (mm)	Diámetro de Caña
TAC34035	75	6.3mm
TAC34045	100	6.3mm

120

Cepillo de alambre para taladro

INDUSTRIAL



Código	Ø (mm)	Diámetro de Caña
TAC37011	24	6mm

240 12

Almohadilla de pulido con brida

7"

INDUSTRIAL

• Para el pulido del capó y papel de lija.



Código	Medida(mm)	Max. rpm
UTAC7121801	180(7"),5/8-11UNC	8500

60 1

Almohadilla de pulido con brida

7"

• Para el pulido del capó.

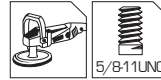

Código	Medida(mm)	Max. rpm
UTAC7111801	180(7"),5/8-11UNC	4000

60 4

Lana para pulir



Código	Medida(mm)
TAC721801	180

80

Hojas de lija para lijadora orbital

10 pzas



Código	Medida	Hoyos	N. de grano
TAC73125101	125mm	8	P40x2 P60x2 P80x3 P120x3
TAC73150101	150mm	8	P800x2 P1000x2 P1200x2 P1500x2 P2000x2
TAC73150102	150mm	8	P80x2 P120x1 P180x2 P240x2 P320x2 P400x1
TAC73150103	150mm	8	P40x2 P60x2 P80x4 P120x2

Juego de lijas delta

20 pzas

INDUSTRIAL



Compatible con TMLI2001

Código	Medida	N. de grano
TAC78080202	80mm	P40x4 P60x4 P80x6 P120x6

40

Hojas de lija para lijadora orbital

5 pzas



Código	Medida	Hoyos	N. de grano
TAC731251	125mm	8	3xP80,2xP120
TAC731501	150mm	8	3xP80,2xP120

80 4

Juego de hojas para lijar

5 pzas

Compatible con lijadora UTF1301826

Código	Medida	N. de grano
TAC749241-1	114x145mm	3xP80,2xP120

100 4

Accesorios para mototool 5 pzas

5 pzas



Código	N. de piezas
TAKB0501	5

100

Accesorios para mototool 357 pzas

357 pzas



Compatible con mototool UTG501032

Código	N. de piezas
TACSD13571	357

10 5

Accesorios para mototool 420 pzas

420 pzas



Compatible con mototool UTG501032

Código	N. de piezas
TAKMG4208	420

20

Juego de hojas para lijar

10 pzas

Medida: 230x280mm
Lijado en húmedo



Código	Grano	Código	Grano
TAC7706001	P60	TAC7728001	P280
TAC7708001	P80	TAC7732001	P320
TAC7710001	P100	TAC7736001	P360
TAC7712001	P120	TAC7740001	P400
TAC7715001	P150	TAC7100001	P1000
TAC7718001	P180	TAC7120001	P1200
TAC7722001	P220	TAC7150001	P1500
TAC7724001	P240	TAC7200001	P2000



80

Hojas para lijar

1 pza

Medida: 11.5x500mm



Código	Grano
TAC760404	P40
TAC760604	P60
TAC760804	P80
TAC761004	P100
TAC761204	P120
TAC761504	P150
TAC761804	P180
TAC762404	P240



60

Piedra para afilar

200x50x25mm



Código	Medida	N. de grano
TAC2620002	200x50x25mm	P120
TAC2623502	235x35x15mm	P120

100

Piedra para afilar combinada

150x50x25mm



Código	Medida	N. de grano
TAC2615001	150x50x25mm	P120 / P240
TAC2620001	200x50x25mm	P120 / P240

50

Accesorios para mototool 13 pzas

13 pzas



Código	N. de piezas
TAKMG3013	13

40

Accesorios para mototool 13 pzas

13 pzas



Código	N. de piezas
TAKMG2013	13

40

Accesorios para mototool 24 pzas

24 pzas



Código	N. de piezas
TAKMG5024	24

40

Accesorios para mototool 30 pzas

30 pzas



Código	N. de piezas
TAKMG1030	30

40

Accesorios para mototool 8 pzas

8 pzas



Código	N. de piezas
TAKMG5008	8

40

Accesorios para mototool 72 pzas

72 pzas



Código	N. de piezas
TAKMG7072	72

40

Fresa lima ovalada

HSS



- Carburo de Tungsteno HSS
- Doble corte



Código	Vástago	Cabeza
TAKC1005	6mm	8mm

200

Fresa lima cilíndrica

HSS



- Carburo de Tungsteno HSS
- Doble corte



Código	Vástago	Cabeza
TAKC1001	6mm	8mm

200

Juego de fresas

5 pzas

- Carburo de Tungsteno HSS
- Doble corte



Código	Vástago	Cabeza
TAKC0651	6mm	8mm

60

Pegamento para pistola

6 pzas

Resina de petróleo



Compatible con pistola UTT101116

Código	Ø (mm)	L (mm)
TACGT2061	11.2	200



120

Mandril sin llave

1/32" - 3/8"

TAC451016

TAC451036

TAC451026
Taladro de impacto



60



Código	Medida	Compatible
TAC451016	0.8 - 10mm	TDL1232-TDL1241-TDL1211-TDL1221-TDL20025-TDL1612
TAC451036	0.8 - 10mm	TDL12002
TAC451026	0.8 - 10mm	TIDL1232 - TIDL1222 - TIDL1612 - TIDL20025

Mandril

1/2" - 5/8"



25



20

Código	Medida	Ø (mm)	Código	Medida	Ø (mm)
TAC451001	1/2"	1.5 - 10	TAC451601	5/8"	3.0 - 16

Mandril de 13mm

Con adaptador SDS de 1/2"



25



25



Código	Medida	Ø (mm)
TAC451301.1	1/2" - 20UNF	1.5 - 13

Código	Medida	Ø (mm)
TAC451301	1/2" - 20UNF	1.5 - 13

Llave para mandril



100/25

Código	Medida	Para mandril
TAC470131	80mm	13mm

Paleta de mezcla

Óptimo para materiales líquidos o fibrosos en grandes cantidades, por ej. Pintura para paredes, barnices, esmaltes, compuestos de sellado de juntas, cal, yeso, relleno, etc.

PINTURA



Mezclar los materiales de arriba y abajo

Código	Diámetro	Largo	Diámetro rosca
TAC331120	120mm	600mm	M14x2
TAC331160	160mm	600mm	M14x2

Set de 15 pzas para flexible multifuncional TMLI2001



Código	Pzas	Compatible
TAKTMT1502	15	TMLI2001

Alicate de combinación

180mm (7")

INDUSTRIAL



SUPER SELECT

60

Código	Longitud
THT110712	180mm (7")

Alicate de combinación

200mm (8")

INDUSTRIAL



SUPER SELECT

60

Código	Longitud
THT110812	200mm (8")

Alicate de punta larga

160mm (6")

INDUSTRIAL



SUPER SELECT

60

Código	Longitud
THT120612	160mm (6")

Alicate de combinación

180mm (7")

INDUSTRIAL



SUPER SELECT

36 6

Código	Longitud
THT110706P	180mm (7")

Juego de alicates

3 pzas

INDUSTRIAL

SUPER SELECT



20 4

Código	Descripción	Longitud
THT1K0311	Alicate punta larga	160mm (6")
	Alicate corte diagonal	160mm (6")
	Alicate de combinación	180mm (7")

Alicate de corte diagonal

160mm (6")

INDUSTRIAL



36 6

Código	Longitud
THT130606P	160mm (6")

Alicate de punta doblada

160mm (6")

INDUSTRIAL



36 6

Código	Longitud
THT1466P	160mm (6")

Alicate pelacables

160mm (6")

INDUSTRIAL



36 6

Código	Longitud
THT1566P	160mm (6")

Juego de alicates

3 pzas

INDUSTRIAL



20 4

Código	Descripción	Longitud
THT1K0301	Alicate punta larga	160mm (6")
	Alicate corte diagonal	160mm (6")
	Alicate de combinación	200mm (8")

Alicate de combinación

160mm, 200mm

INDUSTRIAL



Cr-V

Código	Longitud
THT210606	160mm (6")
THT210806	200mm (8")



Alicate de corte diagonal
160mm (6") INDUSTRIAL



Cr.V

Código	Longitud
THT230606	160mm (6")

Alicate de punta larga
160mm (6") INDUSTRIAL



Cr.V

Código	Longitud
THT220606	160mm (6")

Alicate de punta doblada
160mm (6") INDUSTRIAL



Cr.V

Código	Longitud
THT24616	160mm (6")

Alicate de corte frontal
160mm (6") INDUSTRIAL



Cr.V

Código	Longitud
THT260606	160mm (6")

Alicate de punta larga alto desempeño
200mm (8") INDUSTRIAL



Cr.V

Código	Longitud
THT220806S	200mm (8")



Reduce en 30% la fuerza a aplicar.

Alicates de alto desempeño 3 Pcs INDUSTRIAL



Cr.V

Código	Descripción	Longitud
THT2K0301S	Alicate punta larga	160mm (6")
	Alicate corte diagonal	180mm (7")
	Alicate de combinación	200mm (8")

Alicate de combinación alto desempeño
180mm, 200mm, 240mm INDUSTRIAL



Reduce en 30% la fuerza a aplicar.

Cr.V

Código	Longitud
THT210706S	180mm(7")
THT210806S	200mm(8")
THT210906S	240mm(9.5")

Alicate de corte diagonal alto desempeño
160mm (6") INDUSTRIAL



Reduce en 30% la fuerza a aplicar.

Cr.V

Código	Longitud
THT230606S	160mm (6")

Alicate de corte diagonal heavy duty
180mm (7") INDUSTRIAL



Reduce en 30% la fuerza a aplicar.

Cr.V

Código	Longitud
THT27716S	180mm (7")

Juego de mini alicates
6 pzas INDUSTRIAL



Código	Descripción	Longitud
THT1K0511	Alicate punta larga, corte diagonal, combinación, corte frontal, punta plana, punta doblada	4.5"

Alicate para cortar plástico
160mm (6") INDUSTRIAL



Código	Longitud
THT230612	160mm (6")

Alicate quita abrazaderas 4 pzas
180mm (7") INDUSTRIAL



• 2 pcs de 180°
• 2 pcs de 90° **Más fuerte**

Código	L.	Angulo
THT114041 (viejo)	7"	180°/90°
THTJ214041 (mejorado)	7"	180°/90°

Alicate ajustable
160mm, 200mm, 255mm

INDUSTRIAL



Código	Longitud
THT118062	160mm (6")
THT118082	200mm(8")
THT118102	255mm (10")



Llave de tubo pico de loro
255mm (10")

INDUSTRIAL



Código	Longitud
THT281006	255mm (10")



Llave de tubo pico de loro
255mm (10")

INDUSTRIAL



2X Más rápido

Ajuste rápido



Código	Longitud
THTJ381006	255mm (10")



Alicate de conejo
200mm/255mm

INDUSTRIAL



Código	Longitud
THT2881	200mm (8")
THT28101	255mm (10")



Alicate de carpintero
200mm (8")

INDUSTRIAL



Código	Longitud
THT290801	200mm (8")



Alicate de combinación aislado
200mm (8")

INDUSTRIAL



• Soporta hasta 1,000 voltios



Código	Longitud
THTIP2181	200mm (8")



Alicate de punta larga aislado
200mm (8")

INDUSTRIAL



• Soporta hasta 1,000 voltios



Código	Longitud
THTIP2381	200mm (8")



Alicate de punta doblada aislado
200mm (8")

INDUSTRIAL



• Soporta hasta 1,000 voltios



Código	Longitud
THTIP2481	200mm (8")



Alicate de corte diagonal heavy duty aislado
180mm (7")

INDUSTRIAL



• Soporta hasta 1,000 voltios



Código	Longitud
THTIP2571	180mm (7")



Alicate pelacables aislado
160mm (6")

INDUSTRIAL



• Soporta hasta 1,000 voltios



Código	Longitud
THTIP2661	160mm (6")



Juego de alicates aislados
3 pzas

INDUSTRIAL



• Soporta hasta 1,000 voltios



Código	Descripción	Longitud
THT2K0302	Alicate punta larga	160mm (6")
	Alicate corte diagonal	160mm (6")
	Alicate de combinación	200mm (8")



Juego de herramientas aisladas
6 pzas

INDUSTRIAL

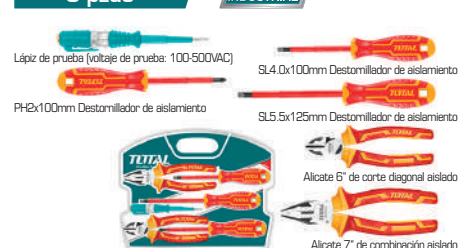

• Soporta hasta 1,000 voltios



Código	Piezas
THKIST3062	6



Destornillador estrella aislado

1000V

INDUSTRIAL



• Certificado VDE



Código	↻	L (mm)	Voltaje
THTISPH180	PH1	80	1000
THTISPH2100	PH2	100	1000

Destornilladores aislados 6 pzas

1000V

INDUSTRIAL



• Certificado VDE

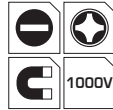

Código	Especificaciones (mm)		
THTIS566	SL3.0x75	PH0x60	
	SL4.0x100	PH1x80	
	SL6.5x150	PH2x100	

Destornillador plano aislado

1000V

INDUSTRIAL



• Certificado VDE

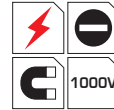

Código	⌀(mm)	L (mm)	Voltaje
THTIS4100	4.0	100	1000
THTIS5125	5.5	125	1000

Juego de destornilladores aislados intercambiables

12 pzas

INDUSTRIAL

1000V



• Soporta hasta 1,000 voltios

Código	Piezas
THKISD1201	12

Juego de destornilladores aislados intercambiables

10 pzas

INDUSTRIAL



1000V



- 1Pcs Test Pencil 140mm
- PH0x110mm
 - PH1x110mm
 - PH2x110mm
 - SL2.5x110mm
 - SL3.0x110mm
 - SL4.0x110mm
 - SL5.5x110mm
 - SL6.5x110mm

• Soporta hasta 1,000 voltios

Código	Piezas
THTIS5106	10

Juego de destornilladores aislados de precisión

6 pzas

INDUSTRIAL

1000V

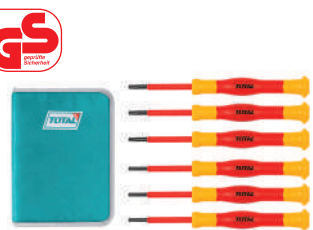

• Soporta hasta 1,000 voltios

Código	Piezas
THKIPSD0601	6

Juego de herramientas aisladas

16 pzas

INDUSTRIAL

1000V



• Soporta hasta 1,000 voltios

Código	Piezas
THKITH1601	16

Juego de herramientas aisladas

19 pzas

INDUSTRIAL

1000V



• Soporta hasta 1,000 voltios

Código	Piezas
THKITH1901	19

Juego de herramientas aisladas

26 pzas

INDUSTRIAL

1000V



• Soporta hasta 1,000 voltios

Código	Piezas
THKITH2601	26

Juego de llaves aisladas

7 pzas

INDUSTRIAL

1000V



• Soporta hasta 1,000 voltios

Código	Piezas
THKISPA0701	7

Juego de llaves aisladas

7 pzas

INDUSTRIAL

1000V



• Soporta hasta 1,000 voltios

Código	Piezas
THKISPA0702	7

Juego de llaves aisladas

6 pzas

INDUSTRIAL

1000V



• Soporta hasta 1,000 voltios

Código	Piezas
THKISPA0603	6

Llave ajustable aislada

8"

INDUSTRIAL

1000V



• Soporta hasta 1,000 voltios

36

Código	Medida
THIADW081	8"

Llave ajustable aislada

10"

INDUSTRIAL

1000V



• Soporta hasta 1,000 voltios

24

Código	Medida
THIADW101	10"

Llave ratchet de 1/2"

1/2"

INDUSTRIAL

1000V



• Soporta hasta 1,000 voltios

20

Código	Medida	Largo
THIRTH121	1/2"	250mm

Llave mango T para socket 1/2"

1/2"

INDUSTRIAL

1000V



• Soporta hasta 1,000 voltios

20

Código	Medida
THITH121	1/2"

Dado hexagonal aislado

1/2"

INDUSTRIAL

1000V



• Soporta hasta 1,000 voltios

24

Código	Medida	Código	Medida
THIHAST12101	10mm	THIHAST12161	16mm
THIHAST12121	12mm	THIHAST12171	17mm
THIHAST12131	13mm	THIHAST12191	19mm
THIHAST12141	14mm		

Cuchillo aislado

50x180mm

INDUSTRIAL

1000V



• Soporta hasta 1,000 voltios

72

Código	Medida
THICK1801	50x180mm

Cuchillo aislado

50x185mm

INDUSTRIAL

1000V



• Soporta hasta 1,000 voltios

72

Código	Medida
THIDCK1851	50x185mm

Tijera aislada

160mm

INDUSTRIAL

1000V



• Soporta hasta 1,000 voltios

72

Código	Medida
THISS1601	160mm

Segueta pequeña aislada

1000V

INDUSTRIAL

1000V



• Soporta hasta 1,000 voltios

48

Código
THIJH3001

Cortador de cable aislado

160mm (6")

INDUSTRIAL



• Soporta hasta 1,000 voltios

36 6

Código	Longitud
THTP2761	160mm (6")

Alicate de combinación aislado

200mm (8")

INDUSTRIAL

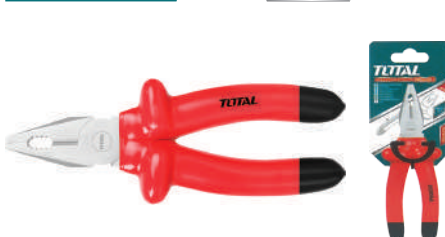

• Probado en 10,000 voltios

36 6

Código	Longitud
THTP181	200mm (8")

Alicate de punta larga aislado

200mm (8")

INDUSTRIAL

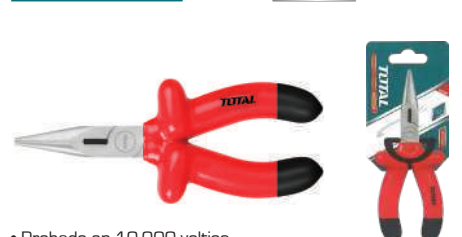

• Probado en 10,000 voltios

36 6

Código	Longitud
THTP381	200mm (8")

Llave de tubo

INDUSTRIAL

8", 10"

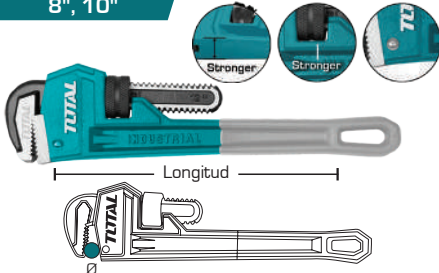

Código	Longitud	Ø (mm)	caja grande	caja chica
THT170806	8"	27	36	6
THT171006	10"	35	24	6

Llave de tubo

INDUSTRIAL

12", 14"

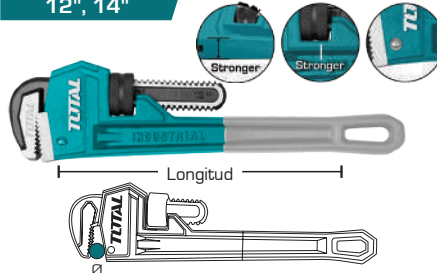

Código	Longitud	Ø (mm)	caja grande	caja chica
THT171206	12"	42	18	3
THT171146	14"	50	12	3

Llave de tubo

INDUSTRIAL

18", 24", 36"



Código	Longitud	Ø (mm)	caja grande	caja chica
THT171186	18"	60	10	2
THT171246	24"	76	4	1
THT171366	36"	85	3	1

Cizalla

14", 18"

INDUSTRIAL



Código	Longitud	Ø (mm)	caja grande	caja chica
THT113146	14"	7(9/32")	16	1
THT113186	18"	8(5/16")	12	12

Cizalla

24", 36"

INDUSTRIAL



Código	Longitud	Ø (mm)	caja grande	caja chica
THT113246	24"	10(3/8")	6	1
THT113366	36"	16(5/8")	1	1

Cizalla

48"

INDUSTRIAL



Código	Longitud	Ø (mm)
THT113486	48"	22(7/8")

Mini cizalla

8"

INDUSTRIAL



Código	Longitud	Ø (mm)
THT11386	8"	3.5(9/64)

Alicate de presión mandíbula curva

255mm (10")

INDUSTRIAL

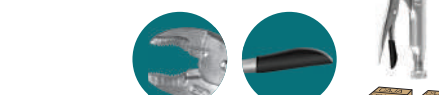

Código	Longitud
THT191001	255mm (10")

Alicate de presión mandíbula curva

175mm (7"), 255mm (10")

INDUSTRIAL



Código	Longitud	caja grande	caja chica
THT190703	175mm (7")	36	6
THT191003	250mm (10")	30	5

Alicate de presión mandíbula recta

255mm (10")

INDUSTRIAL



Código	Longitud
THT191002	250mm (10")

Alicate de presión mandíbula recta

255mm (10")

INDUSTRIAL



Código	Longitud
THT191006	255mm (10")

Alicate de presión punta larga

228mm (9")

INDUSTRIAL



Código	Longitud
THT19902	228mm (9")

Alicate para soldadura

250mm (10")

INDUSTRIAL



Carbon-steel

36 6

Código	Longitud
THT1921003	250mm (10")

Llave de presión C-Clamp

280mm (11")

INDUSTRIAL

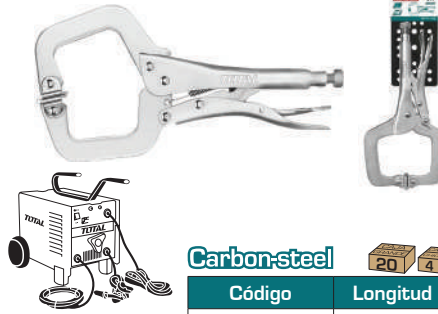

Carbon-steel

20 4

Código	Longitud
THT1111113	280mm (11")

Alicate de presión con cadena

10.5"

INDUSTRIAL



Carbon-steel

20

Código	Longitud cadena
THT1941003	470mm (18.5")

Alicates de filtro de aceite ajustable

255mm (10")

INDUSTRIAL

NEW

Carbon-steel



Apertura: 50-110mm

40

Código	Longitud
THT190905	255mm (10")

Llave de tubo sueca heavy duty de 90°

1 1/2"

INDUSTRIAL

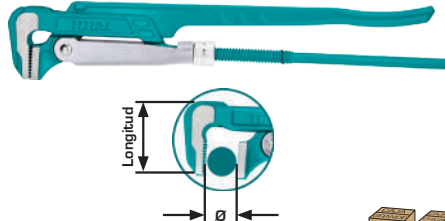

16 16

Código	Longitud	Diámetro Ø (mm)
THT172151	1 1/2"	55(2 3/16")

Llave de tubo sueca heavy duty de 45°

1"

INDUSTRIAL

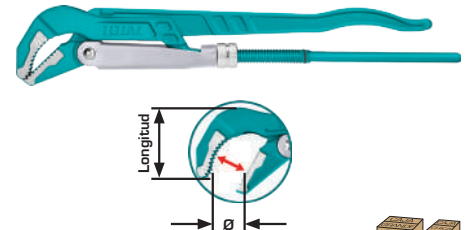

24 24

Código	Longitud	Diámetro Ø (mm)
THT172013	1"	40 (1 9/16")

Llave de tubo con ratched

350mm (14")

INDUSTRIAL

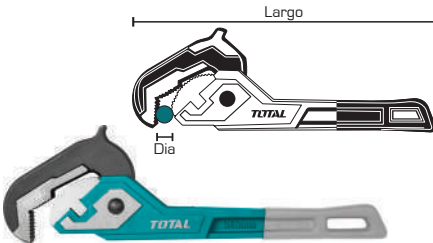

12 6

Código	Longitud	Diámetro
THT171142	350mm (14")	18-52mm

Cortador de cable

200mm (8")

INDUSTRIAL

Carbon-steel



Cables de Aluminio y cobre

50 40

Cr.V

Código	Longitud
THT11581	200mm (8")

Cortador de cable Heavy duty

255mm (10")

INDUSTRIAL



Cables de Aluminio y cobre

36 6

Cr.V

Código	Longitud
THT115102	255mm (10")



Cortador de cable

24"

INDUSTRIAL



Mango de goma cómodo



65Mn



Cables de Aluminio y cobre

6 6

Código	Medida	Max.corte
THT115242	24"	240mm ²

Cortador de cable

36"

INDUSTRIAL



Mango de goma cómodo



65Mn



Cables de Aluminio y cobre

6 6

Código	Medida	Max.corte
THT115362	36"	450mm ²

Separador de cable

0.5 - 6mm

INDUSTRIAL



• Con función de corte

48 12

Código	Medida de corte
THT15606	0.5 - 6mm

Separador de cable

255mm (10")

INDUSTRIAL

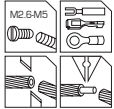

• Con borde afilado para cortar alambre

72 12

Código	Longitud
THT15101	255mm (10")

Separador de cable

215mm (8.5")

INDUSTRIAL



• Con borde afilado para cortar alambre

72

Código	Longitud
THT15851	8.5"

Alicate para crimpar

0.5 - 6mm²

INDUSTRIAL



• Para pestañas y receptáculos no aislados
• AWG: 20-14

40

Código	Longitud
THCPC0506	9"

Alicate para crimpar

1.5 - 6mm²

INDUSTRIAL



• Para terminales no aislados
• AWG: 20-8

40

Código	Longitud
THCPL1506	9"

Alicate para crimpar

0.5 - 6mm²

INDUSTRIAL



• Para terminales aislados y conectores a tope
• AWG: 20-10

40

Código	Longitud
THCPJ0506	9"

Pinza crimpadora

0.25 - 10mm²

INDUSTRIAL



• Para terminales tubulares y preaislados
• AWG: 23-7

40

Código	Longitud
THCPG2510	6"

Pinza crimpadora

4P - 6P - 8P

INDUSTRIAL



• Tres funciones: Crimpado, Pelado, Corte
• Rango de crimpado: 4P, 6P, 8P



36

Código	Longitud
TMPC4468P	8"

Pinza crimpadora 3 en 1

0.2 - 6mm²

INDUSTRIAL



• Multifunción: Pelar, cortar y prensar
• AWG: 10-24

48

Código	AWG
THT15246	10 - 24

Pinza crimpadora 4 en 1

0.2 - 6mm²

INDUSTRIAL



• Multifunción: Detector de voltaje sin contacto, pelar, cortar y prensar
• AWG: 10-24

48

Código	AWG
THT152429	10 - 24

Destornillador plano

SL5 x100mm
SL6 x125mm
SL6 x150mm

INDUSTRIAL



Código	⌀(mm)	Ø(mm)	L(mm)
THTDC2146	5.0	5.0	100
THTDC2156P	6.0	6.0	125
THTDC2166	6.0	6.0	150

Destornillador de estrella

PH1 5x100mm
PH2 6x125mm
PH2 6x150mm

INDUSTRIAL

Código antiguo Código nuevo
THTDC2246 THTDC2246P



Código	⊕	Ø(mm)	L(mm)
THTDC2246	PH1	5.0	100
THTDC2256P	PH2	6.0	125
THTDC2266	PH2	6.0	150

Destornillador plano

SL 4x100mm

INDUSTRIAL



Código	⌀(mm)	Ø (mm)	L (mm)	Modelo
THT264100	4.0	4.0	100	Nuevo

Destornillador plano

SL 5x100mm

INDUSTRIAL



Código	⌀(mm)	Ø(mm)	L(mm)
THT265100	5.5	5.0	100

Destornillador plano

SL5x100mm
SL6x150mm

INDUSTRIAL



Código	⌀(mm)	Ø(mm)	L(mm)
THTDC2146P	5.0	5.0	100
THTDC2166P	6.0	6.0	150

Destornillador plano

SL 6.5x125, 150mm

INDUSTRIAL



Código	⌀(mm)	Ø (mm)	L (mm)
THT266125	6.5	6.0	125
THT266150	6.5	6.0	150

Destornillador plano

SL 8x100mm

INDUSTRIAL



Código	⌀(mm)	Ø(mm)	L(mm)
THT268200	8.0	8.0	200

Destornillador plano

SL 6x38mm

INDUSTRIAL



Código	⌀(mm)	Ø(mm)	L(mm)
THT266038	6.5	6.0	38

Destornillador de estrella

PH1 5x100mm
PH2 6x125mm

INDUSTRIAL



Código	⊕	Ø(mm)	L(mm)
THT26PH1100	PH1	5.0	100
THT26PH2125	PH2	6.0	125

Destornillador de estrella

PH2 6x38mm

INDUSTRIAL



Código	⊕	Ø(mm)	L(mm)
THT26PH2038	PH2	6.0	38

Destornillador Stubby

8 pzas

INDUSTRIAL



Código	Tamaño
TACSDS0706	SL5,SL6,PH0,PH1,PH2,T10,T20

Destornillador Stubby ratched

8 pzas

INDUSTRIAL



Código	Tamaño
TACSDS1726	SL5,SL6,PH0,PH1,PH2,T10,T20

Destornillador de estrella

PH2 6x150mm INDUSTRIAL

Cr.V

Código	Ø (mm)	L (mm)
THT26PH2150	PH2	6.0 150

Destornillador estrella

PH1x100mm
PH2x150mm INDUSTRIAL **NEW**

Cr.V

Código	Ø (mm)	L (mm)
THTDC2246P	5.0	100
THTDC2266P	6.0	150

Destornillador de estrella

PH3 8x150mm INDUSTRIAL

Cr.V

Código	Ø (mm)	L (mm)
THT26PH3200	PH3	8.0 150

Destornillador 6 puntas en 1

INDUSTRIAL

Cr.V

Código	Especificaciones
THT2506076	2 puntas 2 vías: 6.35x65mm, PH1+SL5 8.00x75mm, PH2+SL6 Socket: 6, 8mm

Destornillador Torx

T10 5x100mm
T20 6x150mm INDUSTRIAL

Cr.V

Código	Ø (mm)	L (mm)
THT2346	T10	5.0 100
THT26T20150	T20	6.0 150

Destornilladores

2 pzas INDUSTRIAL

Cr.V

Código	Especificaciones
THT250201	SL6.5x6x125mm(5") PH2x6x125mm(5")

Destornilladores

2 pzas INDUSTRIAL

40Cr

Código	Especificaciones
THTDC250201	1 pzas SL6x125mm(5") 1 pzas PH2x125mm(5")

Destornilladores

4 pzas INDUSTRIAL

40Cr

Código	Especificaciones
THTDC250401	1 pzas SL5x100mm(4") 1 pzas SL6x150mm(6") 1 pzas PH1x100mm(4") 1 pzas PH2x150mm(6")

Destornilladores

4 pzas INDUSTRIAL **NEW**

Cr.V

Código	Especificaciones
THT250604	1 pzas SL5.5x100mm(4") 1 pzas SL6.5x150mm(6") 1 pzas PH1x100mm(4") 1 pzas PH2x150mm(6")

Destornilladores

6 pzas INDUSTRIAL

40Cr

Código	Especificaciones
THTDC250601	1 pzas SL5x75mm(3") 1 pzas SL5x100mm(4") 1 pzas SL6x150mm(6") 1 pzas PH1x75mm(3") 1 pzas PH1x100mm(4") 1 pzas PH2x150mm(6")

Destornilladores de golpe

2 pzas INDUSTRIAL

Acero industrial S2 de alta dureza
Caña hexagonal

S2

Código	Especificaciones
THGSS35121	SL6.5x6x125mm(5") PH2x6x125mm(5")

Destornillador de golpe impacto

13 pzas INDUSTRIAL **NEW**

SL5, SL6, SL8, SL9
PH1, PH2, PH2, PH3, PH4
H4, H5, H6, H8

Cr.V

Código
THIDS1301

Destornilladores de golpe

6 pzas

INDUSTRIAL



Código	Especificaciones
THGSS350B1	1 pzas SL5.5x75mm(3")
	1 pzas SL6.5x100mm(4")
	1 pzas SL8.0x150mm(6")
	1 pzas PH1x75mm(3")
	1 pzas PH2x100mm(4")
	1 pzas PH3x150mm(6")

Destornilladores

8 pzas

INDUSTRIAL



Código	Especificaciones
THTDC250B1	1 pzas SL3.0*3*75 / 1 pzas PH2*6*125
	1 pzas SL5.5*5*100 / 1 pzas PH2*6*38
	1 pzas SL6.5*6*150
	1 pzas SL6.5*6*38
	1 pzas PH0*3*75
	1 pzas PH1*5*75

Destornilladores plano, de estrella y precisión

10 pzas

INDUSTRIAL

SUPER SELECCIÓN



Código	Especificaciones
THTDC251001	1 pzas SL5*75mm / 1 pzas PH1*75mm
	1 pzas SL5*100mm / 1 pzas PH1*100mm
	1 pzas SL6*150mm / 1 pzas PH2*150mm
	4 pzas destornilladores de precisión: SL3*50 / PH0*50 / T6*50 / T8*50

Destornilladores

6 pzas

INDUSTRIAL



Código	Especificaciones
THT250606	1 pzas SL5.5*5*75
	1 pzas SL5.5*5*100
	1 pzas SL6.5*6*150
	1 pzas PH1*5*75
	1 pzas PH1*5*100
	1 pzas PH2*6*150

Destornilladores

8 pzas

INDUSTRIAL



Código	Especificaciones
THT250608	1 pzas SL3.0*3*75 / 1 pzas PH2*6*125
	1 pzas SL5.5*5*100 / 1 pzas PH2*6*38
	1 pzas SL6.5*6*150
	1 pzas SL6.5*6*38
	1 pzas PH0*3*75
	1 pzas PH1*5*75

Destornillador corto

2 pzas

INDUSTRIAL

NEW

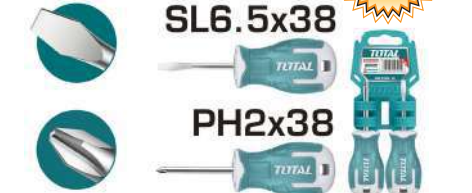

Código	Tamaño
THTS20206	SL6.5, PH2

Juego de destornilladores

2 en 1

INDUSTRIAL

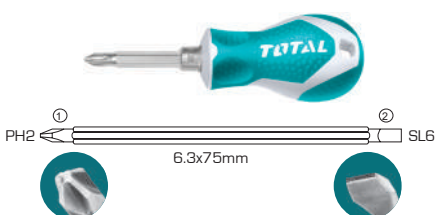

Código	Diámetro de vástago
THT250216	6.3x75mm, PH2+SL6

Juego de destornilladores

2 en 1

INDUSTRIAL

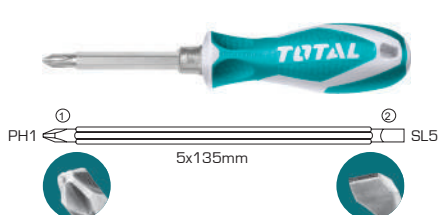

Código	Diámetro de vástago
THT250226	5x135mm, PH1+SL5

Juego de destornilladores

2 en 1

INDUSTRIAL

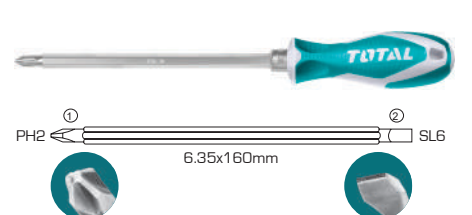

Código	Diámetro de vástago
THT250206	6.35x160mm(6-1/4"), PH2+SL6

Juego de destornilladores

18 en 1

INDUSTRIAL



Código	Diámetro de vástago
THT250236	6.35x160mm

Destornilladores 8pcs y de precisión 10pcs

18 pzas

INDUSTRIAL



Código	Especificaciones
THT250618	1 pcs SL5.5x5x75
	1 pcs SL6.5x6x100
	1 pcs SL8.0x8x150
	1 pcs SL6.5x6x38
	1 pcs PH2x6x38
	1 pcs PH1x5x75
	1 pcs PH2x6x100
	1 pcs PH3x8x150
	1 pcs PH2x6x38
	SL1.5x50 SL2x50 SL2.5x50 SL3x50 PH00x50 PH00x50 PH0x50 T6x50 T8x50 T10x50

Juegos de dados de punta de torx

12 pzas

INDUSTRIAL

NEW



Código	Diámetro
THT1438121	7 Piezas 1/4": T8-10-15-20-25-27-30 5 piezas 3/8": T40-45-47-50-55

Juego de destornilladores

26 pzas

INDUSTRIAL



Cr.V

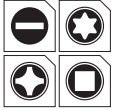

Código	Especificaciones
THTDC252601	7 pzas destornillador plano 11 pzas destornillador estrella 6 pzas destornillador torx 2 pzas destornillador cuadrado

Juego de destornilladores y precisión

14 pzas

INDUSTRIAL



Cr.V



Código	Especificaciones
THT250614	8 Pzas: 1 pzas SL4*100, 1 pzas SL5.5*100 1 pzas SL5.5*150, 1 pzas PH0*75, 1 pzas PH1*100, 1 pzas PH2*150, 1 pzas SL3*38, 1 pzas PH2*38, Precisión: SL1.5*50, SL2*50, PH000*50, PH00*50, T6*50, T8*50

Juego de destornilladores

100 pzas

INDUSTRIAL

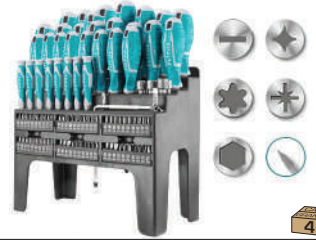

Cr.V



Código	Especificaciones
THT2506100	8 dest. plano, 8 dest. phillips, 3 dest. pozidriv, 3 dest. torx, 8 dest. de precisión, 1 pzas vástago, 1 pza puzón, 60 pzas de destornillador, 2 pzas dest. bidireccional en Z, 6 vástagos de 1/4"

Juego de ganchos

4 pzas

INDUSTRIAL



48 8

Código	Especificaciones
TPHSK0401	1 pza de gancho completo 1 pza de 45 grados 1 pza de 90 grados 1 pza recta

Destornilladores de precisión

32 pzas

INDUSTRIAL

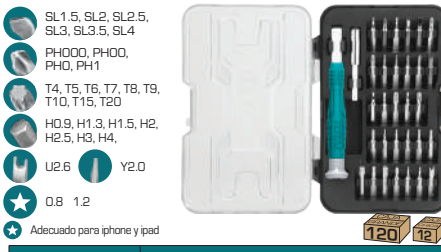

Adecuado para iphone y ipad

Código	Diámetro
THT250PS0321	SL1.5, SL2, SL2.5, SL3, SL3.5, SL4, PH000, PH00, PH0, PH1, T4, T5, T6, T7, T8, T9, T10, T15, T20, H0.9, H1.3, H1.5, H2, H2.5, H3, H4, Y2, U2.6, Five Star 0.8, Five Star 1.2

Destornilladores de precisión

32 pzas

INDUSTRIAL



Código	Diámetro
TACSD30326	SL1.5, SL2, SL2.5, SL3, SL3.5, SL4, PH000, PH00, PH0, PH1, T4, T5, T6, T7, T8, T9, T10, T15, T20, H0.9, H1.3, H1.5, H2, H2.5, H3, H4, Y2, U2.6, Five Star 0.8, Five Star 1.2

Destornilladores de precisión

6 pzas

INDUSTRIAL

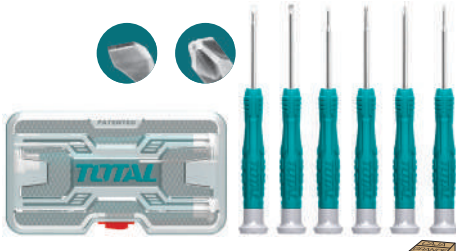

Cr.V

Código	Diámetro
THT250PS0601	SL2.0x50, SL2.5x50, SL3.0x50, PH000x50, PH00x50, PH0x50

Destornilladores de precisión

7 pzas

INDUSTRIAL



Cr.V

Código	Diámetro
THT250726	SL2.0x50, SL2.5x50, SL3.0x50, PH00x50, PH0x50, T6x50, T8x50

Juego destornilladores de ratchet

8 en 1

INDUSTRIAL



22T

Código	N (pzas)
TACSD30086	8

Juego destornilladores intercambiables

9 pzas

INDUSTRIAL



48 4

Código	N (pzas)
THT250906	9

Cr.V

Removedor de tachuela

Juego de destornilladores de eje flexible

12 pzas

INDUSTRIAL

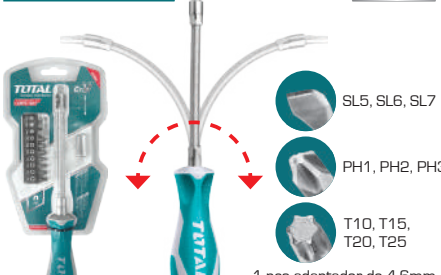

Cr.V

Código	N (pzas)
THT250FL1206	12

Juego de ratchet

13 en 1

INDUSTRIAL



30T

Código	Diámetro
TACSD30136	12 pcs, 6.35x25mm destornilladores SL4,SL5,SL6,SL7,PH0,PH1,PH2,PH3,P20,P21,P22,P23

Juego de destornilladores

24 pzas

INDUSTRIAL



Código	N (pzas)
TACSD302462	24

Destornillador ratchet

15 en 1

INDUSTRIAL

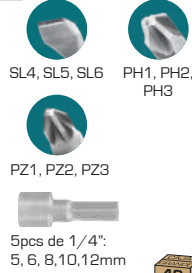

Código	N (pzas)
TACSD30156	15

Destornillador ratchet

24 pzas

INDUSTRIAL

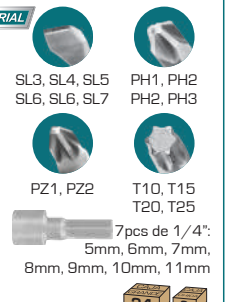

Código	N (pzas)
TACSD30246	24

Destornilladores

26 pzas

INDUSTRIAL



Código	N (pzas)
TACSD30266	26

Destornillador ratchet

7 pzas

INDUSTRIAL



Código	Medida
TNSS0701	6mm, 7mm, 8mm, 9mm, 10mm, 11mm, 12mm

Juego de destornilladores y ratchet

33 pzas

INDUSTRIAL



Código	N (pzas)
TACSD30336	33

Juego de destornilladores y ratchet

55 pzas

INDUSTRIAL



Código	N (pzas)
TACSD30556	55

Juego de destornilladores y ratchet (mango T)

47 pzas

INDUSTRIAL



Código	N (pzas)
TACSD30476	47

Juego de destornilladores y ratchet (mango T)

18 pzas

INDUSTRIAL



Código	N (pzas)
TACSD30186	18

Juego de herramientas de mano

7 pzas

SUPER SELECT



Código	N (pzas)
THKTHP90076	7

Juego de herramientas de mano

9 pzas

INDUSTRIAL



Código	N (pzas)
THKTHP90096	9

Juego de hta. para electricista

11 pzas



Código	N (pzas)
TKETS0111	11

Juego de hta. para electricista

26 pzas



NEW

Código N (pzas)
TKETS0261 26

Juego de hta. de precisión

16 pzas



SL1.5
SL2.0
SL2.5
SL3.0
PH0
PH00
PH000
T6
T8
T10

Código N (pzas)
TKTTSK0162 16

Juego de dados y ratchet 1/4"

12 pzas



DIN 3122 1/4"
DIN 3123 DIN 3124
Cr - V 50BV30 45T

Código N (pzas)
THT14114126 12

Juego de dados y ratchet 1/2"

12 pzas



DIN 3122 1/2"
DIN 3123 DIN 3124
Cr - V 50BV30 72T

Código N (pzas)
THT141121 12

Caja de plástico apilable

340x250x60mm

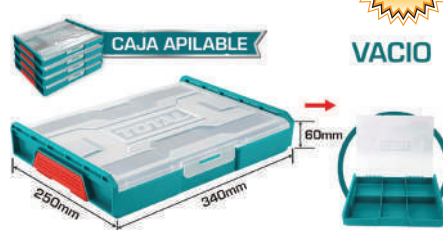

Material: PP

Código Medida(mm)
THKTV02 340x250x60

Herramientas de mano

25 pzas



Puntas de destornillador 20pcs
Cinta métrica 3m
Alicate corte diagonal 6"
Alicate de combinación 7"
Caña para puntas 100mm
Llave ajustable 8"

Código N (pzas)
THKTV02H291 25

Juego de dados y ratchet 1/2"

24 pzas



DIN 3122 1/2"
DIN 3123 DIN 3124
Cr - V 50BV30 45T

Código N (pzas)
THT141253 24

Juego de dados y ratchet 1/2"

25 pzas



DIN 3122 1/2"
DIN 3123 DIN 3124
Cr - V 50BV30 45T

Código N (pzas)
THT121251 25

Caja de herramientas

32 pzas



Código N (pzas)
THKTHP20326 32

Juego de dados y ratchet 1/4"-1/2"

44 pzas



DIN 3122 1/4"
DIN 3123 1/2"
DIN 3123 DIN 3124
Cr - V 50BV30 45T

Código N (pzas)
THT421441 44

Juego de herramientas 1/4"

45 pzas



DIN 3122 1/4"
DIN 3123 DIN 3124
Cr - V 50BV30 45T

Código N (pzas)
THT141451 45

Herramientas para telecomunicaciones

51 pzas



Código N (pzas)
TKTTSK0512 51

Juego de herramientas

100 pzas

INDUSTRIAL

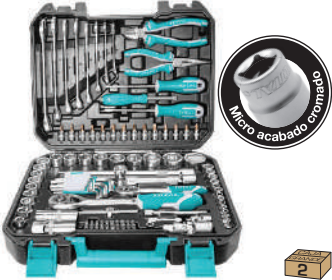

Código	N (pzas)
THKTHP21006	100

Juego de herramientas

130 pzas

INDUSTRIAL



Código	N (pzas)
THKTHP21306	130

Juego de herramientas 1/2"

142 pzas

INDUSTRIAL



Código	N (pzas)
THKTHP21426	142

Caja de herramientas 1/2"

59 pzas

INDUSTRIAL

- 18 Pzas Socket Hexagonal 1/2"
- 12 Pzas Llave fija combinada
- 8 Pzas de destornilladores
- 1 Pzas Llave ratchet 45T 1/2"
- 2 Pzas Barra de extensión 1/2"
- 2 Pzas Llave para bujía 1/2"
- 1 Pzas Junta universal 1/2"
- 1 Pzas Llave flexible 1/2"
- 1 Pzas Alicata de combinación 8"
- 1 Pzas Alicata de punta larga 6"
- 1 Pzas Alicata de corte diagonal 7"
- 1 Pzas Llave ajustable 10"
- 1 Pzas Alicata de presión curvo 10"
- 9 Pzas Llave hexagonal

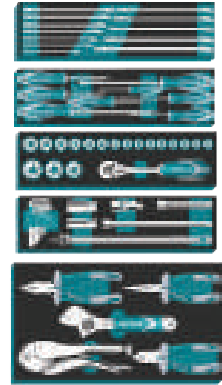

Código	N (pzas)
THTCS12591	59

Maletín de herramientas

147 pzas

INDUSTRIAL

- 1 pzas Lima de acero media caña 200mm
- 1 pzas Nivel de 40cm
- 1 pzas Martillo de 300g
- 1 pzas Segadora de metal 300mm
- 1 pzas Cinta métrica 5M
- 3 pzas juego de llave hexagonal allen
- 1 pzas Alicata de combinación 7"
- 1 pzas Alicata de punta larga 6"
- 1 pzas Alicata de corte diagonal 6"
- 1 pzas Pelacables 6.5"
- 1 pzas Alicata para bomba de agua 10"
- 1 pzas Llave ajustable 8"
- 1 pzas Alicata de presión curvo 10"
- 1 pzas Tijera 6.5"
- 9 pzas Llaves combinadas
- 4 pzas Destornilladores planos
- 3 pzas Destornilladores estrella
- 1 pzas Visiámetro magnético 1/4"
- 2 pzas Destornillador magnético
- 1 pzas Lápiz de prueba
- 1 pzas Llave ratchet 45T 1/2"
- 1 pzas Llave ratchet 45T 1/4"
- 1 pzas Mango giratorio 1/4"
- 1 pzas Barra de extensión flexible 1/4"
- 1 pzas Adaptador de tres vías 1/2"(F)*3/8"(M)
- 1 pzas Junta Universal 1/2"
- 1 pzas Junta Universal 1/4"
- 2 pzas Barra de extensión 1/2" x 5" - (10")
- 2 pzas Barra de extensión 1/4" (2") - (4")
- 13 pzas Socket Hexagonal 1/2"
- 13 pzas Socket Hexagonal 1/4"
- 2 pzas Socket para bujía 1/2"
- 1 pzas Cuchilla
- 10 pzas Juego de hojas para cuchillas
- 1 pzas Barra de extensión 1/4" x 6"
- 1 pzas Porta puntas 1/4"
- 2 pzas puntas de destornilladores 1"
- 2 pzas Tornillos:
 - Madera 2,0mm (6 pzas)
 - 2,5mm (6 pzas)
- Autoperforantes 2,5mm (7 pzas)
- 3mm (7 pzas)
- 1 pzas Porta puntas magnético



Código	N (pzas)
THKTHP21476	147

Caja de herramientas

97 pzas

INDUSTRIAL

- Tamaño: 520*218*243mm
- Espesor: 0,8mm
- Espesor de cajón: 0,5mm
- 1 Bandeja superior: 506*215*63mm
- 2 Cajones de 449*196*54mm
- Incluye:
 - 1 pzas Llave ratchet 1/2"
 - 1 pzas Llave ratchet 1/4"
 - 8 pzas Socket Hexagonal 1/2"
 - 1 pzas Junta Universal 1/2"
 - 1 pzas Junta Universal 1/4"
 - 1 pzas Barra de extensión 1/2" x 6"
 - 1 pzas Barra de extensión 1/4" x 4"
 - 1 pzas Barra T deslizando 1/2" x 250mm
 - 2 pzas Socket para bujía 1/2"
 - 13 pzas Socket Hexagonal 1/4"
 - 1 pzas Mango giratorio 1/4"
 - 1 pzas Porta puntas
 - 20 pzas Puntas
 - 9 pzas llaves hexagonales allen

- Cajón 1:
 - 7 pzas Destornilladores
 - 11 pzas Llaves de combinación
- Cajón 2:
 - 1 pzas Alicata para bomba de agua 10"
 - 1 pzas Alicata de combinación 6"
 - 1 pzas Alicata de punta larga 6"
 - 1 pzas Alicata de corte diagonal 6"
 - 1 pzas Cuchilla
 - 1 pzas Llave ajustable 10"
 - 1 pzas Cinta métrica 3m



Código	N (pzas)
THPTCS70971	97

Caja de herramientas

162 pzas

INDUSTRIAL

- Con 7 cajones para piezas.
- Tamaño total con ruedas: 765x465x976mm.
- Tamaño de ruedas: 5"x2".
- Espesor del gabinete: 0.8 - 1.0mm
- Espesor de cajones: 0.7mm
- Tamaño de 5 cajones: 536x410x74.5mm.
- Tamaño de 2 cajones: 536x410x153.5mm

Código	N (pzas)
THPTCS71621	162

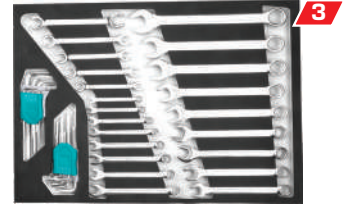
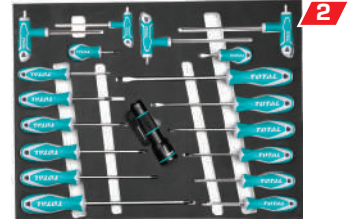
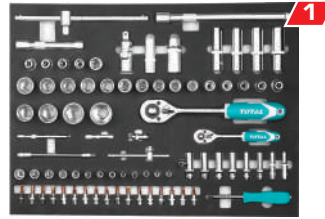

Caja de herramientas con ruedas

765x465x976mm

INDUSTRIAL

NEW



Código	Gavetas
THRC01071	7

Caja de herramientas con ruedas

680x458x945mm

INDUSTRIAL

NEW



Código	Gavetas
THRC02071P	7

Caja de herramientas con ruedas

765x465x976mm

INDUSTRIAL

NEW



Código	Gavetas
THRC01041	4

Carrito de servicio mecánico

616x330x780mm

INDUSTRIAL

NEW



Código	Bandejas
THPTC301	3

Carrito de servicio mecánico

712x440x814mm

INDUSTRIAL

NEW



Código	Bandejas
THPTC201	2

Caja herramientas metálica

520x218x243mm

INDUSTRIAL

NEW



Código	Bandejas
THPTC202	2

Martillo de bola

16oz/24oz

INDUSTRIAL

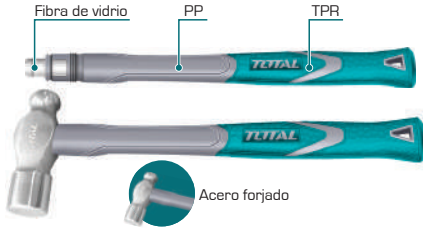

Código	P (oz)	P (g)	caja grande	caja chica
THT74166	16	450	18	6
THT74246	24	660	18	6

Martillo de bola

32oz/48oz

INDUSTRIAL

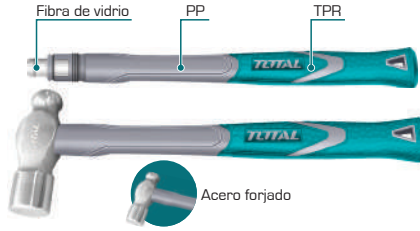

Código	P (oz)	P (g)	caja grande	caja chica
THT74326	32	900	12	2
THT74486	48	1300	12	2

Martillo de orejas

8oz/16oz



SUPER SELECT

Código	P (oz)	P (g)
THTS7308	8	220
THTS7316	16	450

Martillo de punta

100g/200g/300g/
1000g/2000g

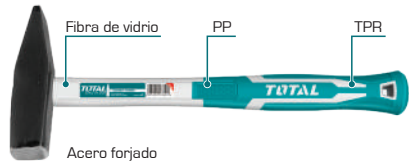

Código	Peso	C. grande	C. chica
THT711006	100g	48	8
THT712006	200g	48	8
THT713006	300g	36	6
THT7110006	1000g	12	2
THT7115006	1500g	12	2
THT7120006	2000g	12	2

Martillo de orejas

16oz

INDUSTRIAL

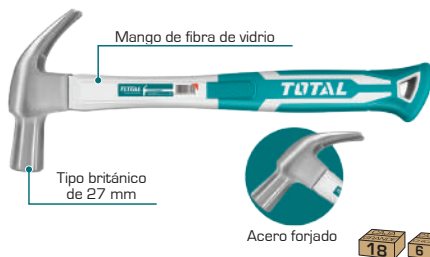

Código	P (oz)	P (g)
THT73227	16	450

Martillo de orejas

20oz

INDUSTRIAL



Código	P (oz)	P (g)
THT73206	20	560

Martillo de orejas

16oz/20oz

INDUSTRIAL

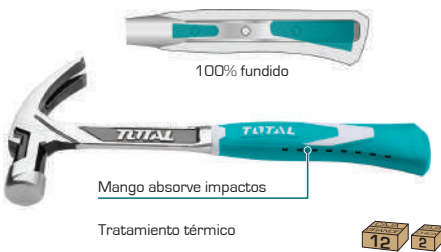

Código	P (oz)	P (g)
THT7143166	16	450
THT7143206	20	560

Martillo de orejas

8oz/16oz

INDUSTRIAL



Código	P (oz)	P (g)
THTCH0086	8	220
THTCH0166	16	450

Mini martillo de orejas

8oz

INDUSTRIAL

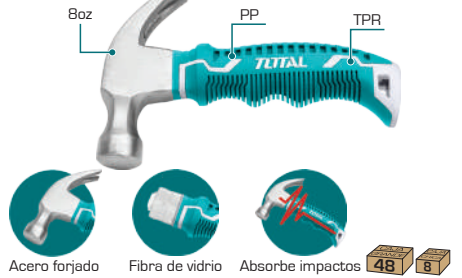

Código	P (oz)
THTM7386D	8

Set de martillos para chapistería

7 pzas

NEW



Código	Piezas
TBAFO712	7

Martillo forjado

500g

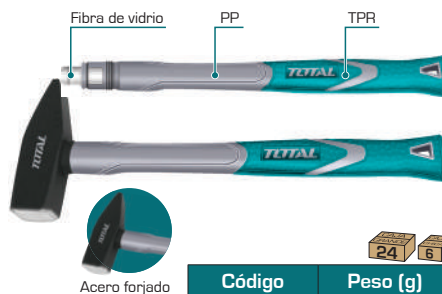

Código	Peso (g)
THT715006	500

Martillo de punta

600g

INDUSTRIAL



Código	P (g)
THTRH6006	600

Martillo uña tipo frances

700g

INDUSTRIAL



Código	P (g)
THCHIT7006	700

Martillo de punta

300g

INDUSTRIAL



Código	P (g)
THTMH3006	300

Mazo de goma y plástico

40mm

INDUSTRIAL



Código	Medida
THT77406	40mm(1-9/16")

Mazo de goma

8oz/16oz

INDUSTRIAL



Código	P (oz)	P (g)	caja grande	caja chica
THT76836	8	220	40	6
THT761636	16	450	24	6

Mazo de goma

8oz/16oz

INDUSTRIAL

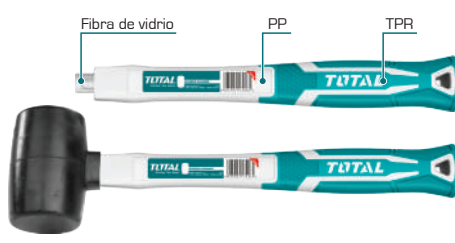

Código	P (oz)	P (g)	caja grande	caja chica
THT76816	8	220	40	4
THT761616	16	450	24	4

Mazo forjado

1000oz/1500oz/2000oz

INDUSTRIAL



Código	Peso
THT7215006	1500g /3.3lb
THT720006	2000g /4.4lb

Mazo forjado

1000g



Código	Peso
THS721000	1000g /2.2lb

Mazo

1000g

INDUSTRIAL



Código	P (g)
THTSTH10006	1000

Mazo forjado

1500g

INDUSTRIAL



Código	P (g)
THTSTH15006	1500

Mazo demoledor

2lb/3lb/4lb

INDUSTRIAL

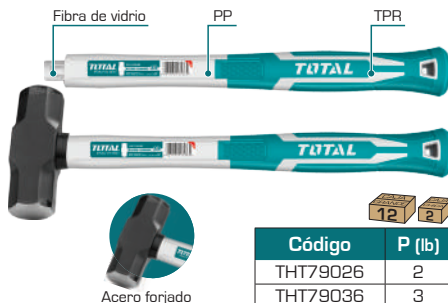

Código	P (lb)
THT79026	2
THT79036	3
THT79046	4

Mazo de golpe muerto

2lb

INDUSTRIAL



- Hecho de plástico no daña superficies.
- No rebota.
- No produce chispa.

Código	Peso (lb)
THT79021	2



Mazo y hacha

6lb



Código	Peso	L (mm)
THT78206D	6lb	900

Mazo

5000g



Código	Peso	L (mm)
THT72056D	5000g	900

Mazo demoledor

10lb/11lb/12lb

INDUSTRIAL



Código	Peso	L (mm)
THT750416	10 lb	900
THT720516	11 lb	900
THT750516	12 lb	900

Martillo forjado

300g



Código	Peso
THTW71300	300g

Mazo forjado

1000g



Código	Peso
THTW721000	1000g

Martillo de orejas

16oz



Código	P (oz)	P (g)
THTW7316	16	450

Hacha de mano

800g

INDUSTRIAL



Código	Peso (g)
THT788006	800

Hacha de mano

600g/1250g

INDUSTRIAL

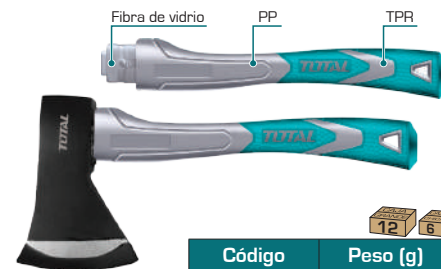

Código	Peso (g)
THT786006	600
THT7812506	1250

Hacha grande

2000g

INDUSTRIAL



Código	Peso (g)
THT798026	2000

Cinceles de madera

6mm

INDUSTRIAL



Código	Ancho	L (mm)
THT4166	6mm	140

Cinceles de madera

12,14,16,19mm

INDUSTRIAL

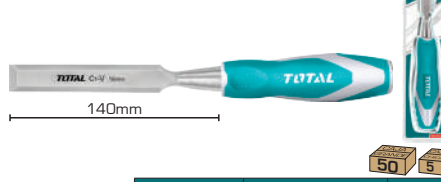

Código	Ancho	L (mm)
THT41126	12mm	140
THT41146	14mm	140
THT41166	16mm	140
THT41196	19mm	140

Cinceles de madera

25mm

INDUSTRIAL

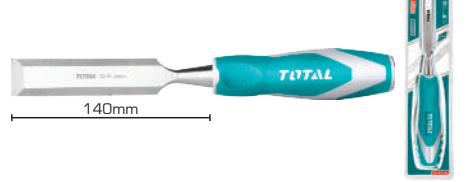

Código	Ancho	L (mm)
THT41256	25mm	140

Cinceles de madera

4pz

INDUSTRIAL

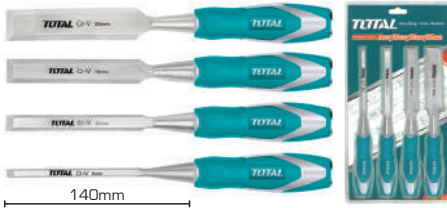

140mm

16 12

Cr.V

Código	Ancho	L (mm)
THT41K0401	6mm, 12mm, 19mm, 25mm	140

Cinceles de hormigón

4x16x250
4x19x305

INDUSTRIAL



20 5

Código	Medida (mm)
THT4211026	4x16x250

Cinceles económicos

22x16x250
24x18x300

INDUSTRIAL



20 5

Código	Medida (mm)
THT4211026	22x16x250
THT4211226	24x18x300

Cinzel de hormigón

4x19x305

INDUSTRIAL



24 6

Código	Medida (mm)
THT4421219	4x19x305

kit de centro punto

6 pzas

INDUSTRIAL



24 3

Código	Medida (mm)
THT42K0601	1.5, 3, 4, 5, 6, 8

Juego de extracción de tornillos

5 pzas

INDUSTRIAL

NEW

Dureza: 48 - 52HRC

Cr.V



24

Código	Medida (mm)
TACSE0056	3 - 6 (1#), 6 - 8 (2#), 8 - 11 (3#), 11 - 14 (4#), 14 - 18 (5#)

Abrazaderas G

4", 6"

INDUSTRIAL



Código	Medida	Caja G.	Caja C.
THT13141	4"	24	6
THT13161	6"	16	4

Abrazaderas G

8"

INDUSTRIAL

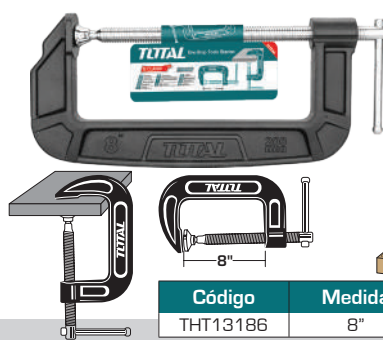

Código	Medida
THT13186	8"

Abrazaderas tipo F

50x250mm, 120x300mm
120x800mm, 140x1200mm

INDUSTRIAL

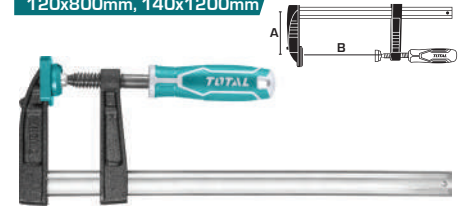

Código	Medidas(AxB)	Fuerza (kgs)
THT1320503	50x250mm	170
THT1321201	120x300mm	450
THT1321204	120x800mm	450
THT1321402	140x1200mm	550

Abrazaderas de barra rápida

63x150mm
63x300mm
63x450mm

INDUSTRIAL

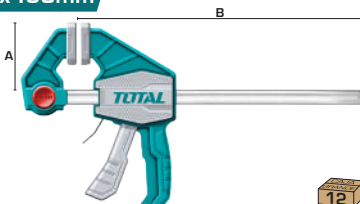

12 12

Código	Medidas(AxB)	Fuerza (kgs)
THT1340601	63x150mm (6")	60
THT1340602	63x300mm (12")	60
THT1340603	63x450mm (18")	60

Abrazaderas de barra rápida

80x600mm
80x900mm

INDUSTRIAL

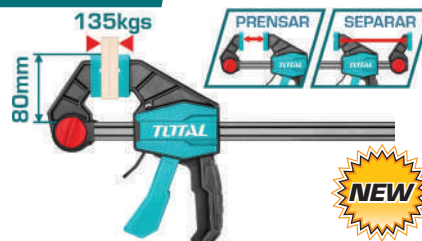

NEW

Código	Medidas	Fuerza (kgs)
THT1346802	80x600mm (24")	135
THT1346803	80x900mm (36")	135

Pinzas de resorte

4", 6"

INDUSTRIAL



Código	Medidas(A)	Fuerza (kgs)	Max. apertura
THT13342	110mm (4")	12	50 mm
THT13362	150mm (6")	15	68 mm

Prensa de banco

4", 6", 8"

INDUSTRIAL



• Base giratoria

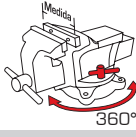

FUNDICIÓN DÚCTIL

Código	Medida	Peso(kg)	Fuerza(kgs)
THT6146	4"	6.7	1300
THT6166	6"	11.2	1600
THT6186	8"	21	2500

Prensa de banco

60mm

INDUSTRIAL



Código	Medida	Peso(kg)	Fuerza(kgs)
THT6126	60mm	1.7	1000

Lima plana para acero

200mm

INDUSTRIAL

Innovado por TOTAL
Patent No: ZL 2015 3 0167717.0

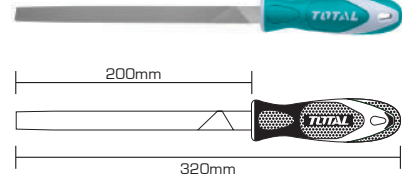

Código	Longitud
THT91186P	200mm(8")

Lima semi circular para acero

200mm

INDUSTRIAL

Innovado por TOTAL
Patent No: ZL 2015 3 0167717.0

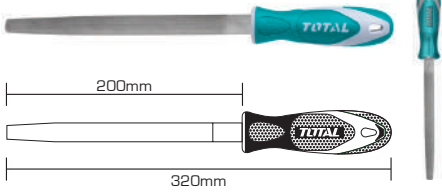

Código	Longitud	Modelo
THT91286P	200mm(8")	Nuevo

Lima redonda para acero

200mm

INDUSTRIAL

Innovado por TOTAL
Patent No: ZL 2015 3 0167717.0

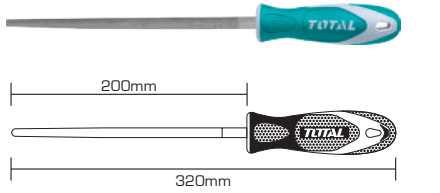

Código	Longitud
THT91386P	200mm(8")

Lima triangular para acero

200mm

INDUSTRIAL

Innovado por TOTAL
Patent No: ZL 2015 3 0167717.0

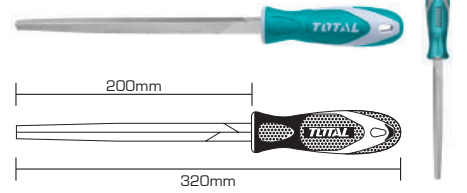

Código	Longitud	Modelo
THT91486P	200mm(8")	Nuevo

Lima cuadrada para acero

200mm

INDUSTRIAL

Innovado por TOTAL
Patent No: ZL 2015 3 0167717.0

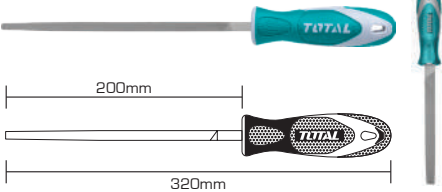

Código	Longitud
THT91886	200mm(8")

Lima redonda para madera

200mm

INDUSTRIAL

Innovado por TOTAL
Patent No: ZL 2015 3 0167717.0

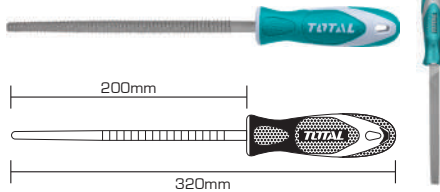

Código	Longitud
THT91786	200mm(8")

Lima plana para madera

200mm

INDUSTRIAL

Innovado por TOTAL
Patent No: ZL 2015 3 0167717.0

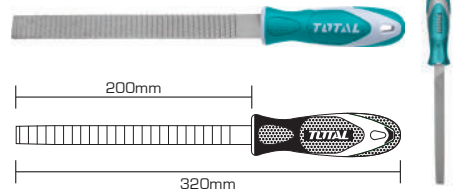

Código	Longitud
THT91586	200mm(8")

Lima semi circular para madera

200mm

INDUSTRIAL

Innovado por TOTAL
Patent No: ZL 2015 3 0167717.0

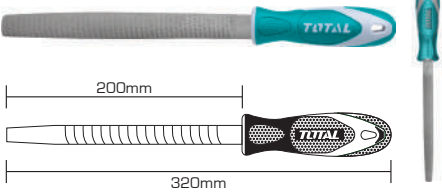

Código	Longitud
THT91686	200mm(8")

Limas para acero 5pcs

200mm

INDUSTRIAL

Innovado por TOTAL
Patent No: ZL 2015 3 0167717.0



Código	Descripción	Longitud
THT918516	Lima redonda para acero	200mm (8")
	Lima cuadrada para acero	200mm (8")
	Lima triangular para acero	200mm (8")
	Lima plana para acero	200mm (8")
	Lima semi circular para acero	200mm (8")

Limas para madera 3pcs

200mm

INDUSTRIAL

Innovado por TOTAL
Patent No: ZL 2015 3 0167717.0



Código	Descripción	Longitud
THT918326	Lima redonda para madera	200mm (8")
	Lima semi circular para madera	200mm (8")
	Lima plana para madera	200mm (8")

Juego de limas 6pcs

140mm

INDUSTRIAL

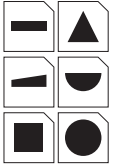

Código	Medida
THT91462	140mm

Serrucho de costilla

12"

INDUSTRIAL



Código	Dientes	Medida
THT59126B	11TPI	300mm(12")

Serrucho de mano

16"

INDUSTRIAL



LARGA VIDA CORTE RÁPIDO 7TPI SK5



Código	Dientes	Medida	Modelo
THT55166D	7TPI	400mm(16")	Antiguo
NEW THT551662D	7TPI	400mm(16")	Mejorado

Serrucho de mano

16"



PVC Madera
7TPI 65Mn



SUPER SELECT

Código	Dientes	Medida
THT551663D	7TPI	400mm(16")

Serrucho de mano

16", 18"



PVC Madera
7TPI 65Mn



SUPER SELECT

Código	Dientes	Medida
THT55400	7TPI	400mm(16")
THT55450	7TPI	450mm(18")

Serrucho de mano

20"

INDUSTRIAL



7TPI 65Mn

Código	Dientes	Medida
THT55206	7TPI	500mm(20")

Serrucho de mano

22"

INDUSTRIAL



65Mn 7TPI Wood PVC

Código	Dientes	Medida
THT55226	7TPI	550mm(22")

Serrucho para hormigón ligero

24"

INDUSTRIAL



- Dientes de acero de tungsteno.
- Para cortar hormigón celular, ladrillo de cenizas, placa de yeso, bloque de hielo.

Código	Dientes	Medida
THTLCS1241	17T	600mm(24")

Set de caja y serrucho

12"

INDUSTRIAL



- Caja de 300 x 140 x 80 mm

Código	Espesor	Medida
THTK591262	20mm	300mm(12")

Cepillo para madera

235mm

INDUSTRIAL



THT9391BL
Cuchilla para cepillo
(se vende por separado)



Código	Longitud
THT9391	235mm

Cepillo para madera

250mm (10")

INDUSTRIAL



ULTRA ALTA PRECISIÓN

No.4#

Heavy duty

Código	Longitud
THTPO204	250mm

Cepillo para madera

350mm (14")

INDUSTRIAL



ULTRA ALTA PRECISIÓN

No.5#

Heavy duty

Código	Longitud
THTPO205	350mm

Cepillo para madera 450mm (16")

INDUSTRIAL



ULTRA ALTA PRECISION

No. 6#

Heavy duty

Código	Longitud
THTP0206	450mm

Cepillo escochebre para madera 230mm (9")

INDUSTRIAL



Superficie plana

Superficie cóncava

Código	Longitud	Superficie
THTP03091	230mm (9")	Recta
THTP03092	230mm (9")	Cóncava

Cepillo para yeso 250mm

INDUSTRIAL



Código	Longitud
THBP01250	250mm

Serrucho para gypsum 150mm (6")

INDUSTRIAL



CORTE RÁPIDO

SK5 8TPI

Código	Longitud(mm)
THWBSW66	150 (6")

Serrucho para gypsum 300mm (12")

INDUSTRIAL



CORTE RÁPIDO

SK5 7TPI

Código	Longitud(mm)
THCS3006	300 (12")

Mini segueta para metal 150mm (6")

CUERPO DE ALUMINIO



Hoja de 24TPI

- Incluye hoja de segueta
- Trabajo pesado

Código	Longitud
THMHF1503	150mm(6")

Mini segueta para metal 150mm (6")



- Incluye hoja de segueta

Código	Longitud
THMHF1501	150mm(6")

Set de 10 hojas mini segueta 150mm (6")



65Mn

24TPI

Bi-metal 65 Mn

Código	Dientes	Longitud(mm)
TMHSB1501	24T	150 (6")

Mini segueta ajustable 10" - 12"



- Ajuste para hoja de 10" y 12"

Código	Ajuste de hoja
THMHF1504	250mm/300mm

Segueta 300mm (12")

INDUSTRIAL



- Incluye hoja de segueta de 65Mn

Código	Longitud
THT54106	300mm(12")

Segueta 300mm (12")



- Incluye hoja de segueta de 65Mn

Código	Longitud
THT541026	300mm(12")

Segueta 300mm (12")



- Incluye hoja de segueta de 65Mn

Código	Longitud
THT541036	300mm(12")

Hoja para següeta Bi-metal

300mm (12") INDUSTRIAL



M42+D6A

500 5

Bi-metal	M42 + D6A	Código	Dientes	Longitud(mm)
		THT571186	18T	300 (12")
		THT572248	24T	300 (12")
		THT571326	32T	300 (12")

Set de 5 hojas para següeta

300mm (12") INDUSTRIAL



M42+D6A

500 5

Bi-metal	M42 + D6A	Código	Dientes	Longitud(mm)
		THTKT57185	18T	300 (12")
		THTKT57245	24T	300 (12")

Set de 5 hojas para següeta

300mm (12") INDUSTRIAL



M2+D6A

100

Bi-metal	M2 + D6A	Código	Dientes	Longitud(mm)
		THTKT58185	18T	300 (12")
		THTKT58245	24T	300 (12")

Exacto de plástico

173mm INDUSTRIAL



SK5

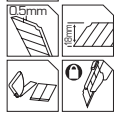

96 12

Código	L	Ancho h.
THT511816	100mm	18mm

Exacto de metal con ángulo

61mm INDUSTRIAL



SK5



x5

72 6

Código	L(mm)	Ancho h.
THT512614	61	19mm

Exacto de plástico

173mm INDUSTRIAL



SK5

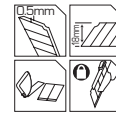

96 6

Código	Largo h.	Ancho h.
THT511826	100mm	18mm

Exacto de aluminio

185mm INDUSTRIAL



SK5

AL



x6

48 6

Código	Largo h.	Ancho h.
TG5121806	100mm	18mm

Exacto de aleación de zinc

175mm INDUSTRIAL



SK5

Zn



x6

48 6

Código	Largo h.	Ancho h.
TG5126101	61mm	19mm

Exacto de aluminio

180mm INDUSTRIAL



SK5

AL



x5

72 12

Código	Largo h.	Ancho h.
THT5116118	61mm	19mm

Exacto de aluminio

172mm INDUSTRIAL



SK5

AL

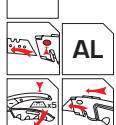

x6

72 12

Código	Largo h.	Ancho h.
THT5126128	61mm	19mm

Exacto plegable de aluminio

61x19mm INDUSTRIAL



SK5

AL



x5

72 6

Código	Largo h.	Ancho h.
THT5136138	61mm	19mm

Exacto de plástico

135mm INDUSTRIAL



Código	Largo h.	Ancho h.
THT5110915	80mm	9mm

Exacto de plástico
152mm



SUPER SELECT

300

Código	Largo h.	Ancho h.
THT51001	100mm	18mm

Exacto de plástico
152mm

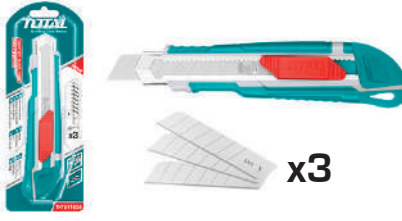

SUPER SELECT

Incluye 3 hojas SK5

96

Código	Largo h.	Ancho h.
THT522136	100mm	18mm

Exacto de acero inoxidable
130mm INDUSTRIAL



THT5110906-Caja 48pcs

576 12

Código	Largo h.	Ancho h.
THT5110906	80mm	9mm

Cuchillas para exacto
10 pzas INDUSTRIAL

10pcs

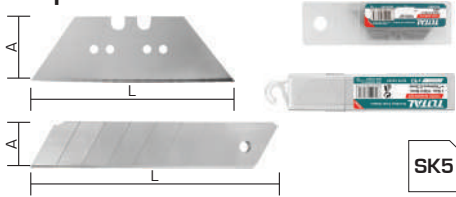

SK5

Código	L(mm)	A(mm)	caja grande	caja chica
THT519001	61	19	200	50

Cuchillas para exacto
10 pzas INDUSTRIAL **NEW**

10pcs



400

Código	L(mm)	A(mm)
THT5190901	80	9

Cuchillas para exacto
10 pzas INDUSTRIAL **NEW**

10pcs



120

Código	L(mm)	A(mm)
THT519112	100	18

Cuchillas para exacto
10 pzas INDUSTRIAL **NEW**

10pcs



200

Código	L(mm)	A(mm)
THT519001	61	19

Cuchillas para exacto
10 pzas INDUSTRIAL **NEW**

10 pzas



100

Código	L(mm)	A(mm)
THT5192501	127	25

Cuchillo de bolsillo
198mm INDUSTRIAL

- Cuchillo curvado de acero especial
- Mango de madera



72 12

Código	Longitud	Espesor
THT51082	198mm	2.5mm

Cuchilla recta para pelar cables
200mm INDUSTRIAL



HOJA RECTA

- Material de acero inoxidable.

72 8

Código	L
THT51881	200mm

Cuchilla curva para pelar cables
200mm INDUSTRIAL



HOJA CURVA

- Material de acero inoxidable.

72 8

Código	L
THT51882	200mm

Cuchilla plegable
180mm INDUSTRIAL



x6

- Material de acero inoxidable.

72 8

Código	Largo h.	Ancho h.
THT5136288	61mm	19mm



Cuchilla de acero inoxidable

180mm

INDUSTRIAL



HOJA CURVA

- Material de acero inoxidable.

Código	L
THT51886	180mm

Navaja multifuncional

12 funciones

INDUSTRIAL



Código	Medida(mm)
THMFK0126	95

Navaja multifuncional

15 funciones

INDUSTRIAL



- 15 funciones:
Tijeras, serrucho, destornillador y más
Mango de aluminio endurecido

Código	Medida(mm)
THMFK0156	95

Llaves de tuercas tipo navaja

6 en 1

INDUSTRIAL



Código	Medidas(mm)
THFND061	5,6,8,9,10,12

Martillo multifuncional

12 funciones

INDUSTRIAL



Código	Funciones
THMHF0126	12

Herramienta multifuncional plegable

15 funciones

INDUSTRIAL



- Alicate plegable en acero inoxidable
Incluye estuche

Código	Medida(mm)
TFMFT01151	155

Tijera

215mm, 275mm

INDUSTRIAL



- Material de acero inoxidable.
- Espesor de hojas: 2.5mm.

Código	Medida(mm)
THSCRS812001	215
THSCRS812801	275

Tijera de electricista

178mm(7")

INDUSTRIAL

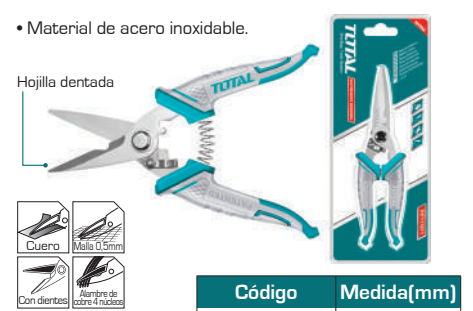

- Material de acero inoxidable.

Hojilla dentada



Código	Medida(mm)
THT117871	178

Tijera de electricista

200mm(8")

INDUSTRIAL



- Material de acero inoxidable.

Hojilla dentada



Código	Medida(mm)
THT118871	200

Tijera de electricista

145mm

INDUSTRIAL



- Material de acero inoxidable.
- Espesor de hojas: 3.0mm.

Código	Medida(mm)
THT115871	145

Tijera de cocina

225mm (9")

INDUSTRIAL



- Material de acero inoxidable.
- Espesor de hojas: 3.0mm.
- Corta carne, abre botella, abre lata, raspador de escama y rompe cascanuez.

Código	Medida(mm)
THSCRS822251	225

Raspador de ventana

7" (175mm)

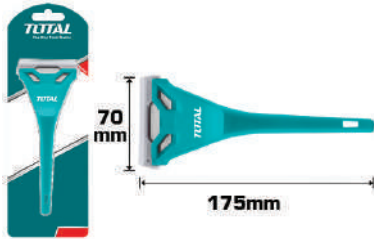

Código	L(mm)	Peso(g)
THT181751	175	23

Raspador con mango

5 pzas

INDUSTRIAL



Código	L(mm)	W(g)
THT183201	310	260

Tijera aviador

Izquierda

INDUSTRIAL

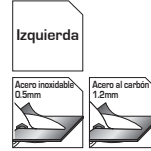

Código	Longitud(mm)
THT521106	255 (10")

Tijera aviador

Derecha

INDUSTRIAL

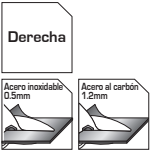

Código	Longitud(mm)
THT523106	255 (10")

Tijera aviador

Recta

INDUSTRIAL

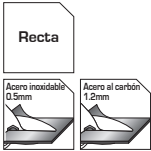

Código	Longitud(mm)
THT522106	255 (10")

Juego de Tijeras aviador

3 pzas

INDUSTRIAL



Código	Longitud(mm)
THT520106K	255 (10")

Tijera aviador

Izquierda

INDUSTRIAL



• Hecho de cromo-molibdeno, una aleación que permite una larga vida útil.

Código	Longitud(mm)
THTJ531106	255 (10")

Tijera aviador

Derecha

INDUSTRIAL

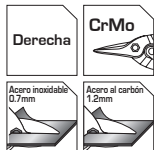
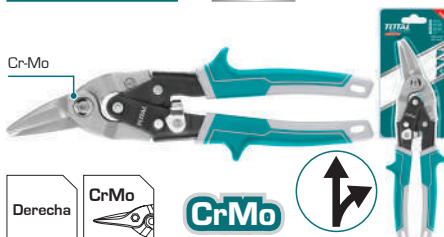

• Hecho de cromo-molibdeno, una aleación que permite una larga vida útil.

Código	Longitud(mm)
THTJ533106	255 (10")

Tijera aviador

Recta

INDUSTRIAL

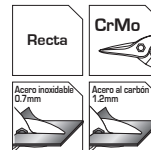

• Hecho de cromo-molibdeno, una aleación que permite una larga vida útil.

Código	Longitud(mm)
THTJ532106	255 (10")

Tijera aviador larga

Recta

INDUSTRIAL

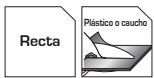

• Para plástico, caucho o red de alambre de latón de 0.5 mm.

Código	Longitud(mm)
THT525106	300 (12")

Tijera de hojalatero

10"

INDUSTRIAL

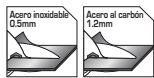

Código	Longitud(mm)
THT524101	255 (10")

Tijera de hojalatero

10"

INDUSTRIAL

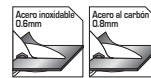

Código	Longitud(mm)
THTJ534101	255 (10")

Tijera de hojalatero

12"

INDUSTRIAL

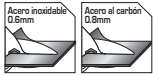

Código	Longitud(mm)
THT524121	305 (12")

Tijera de hojalatero

12"

INDUSTRIAL

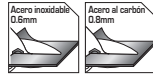

Código	Longitud(mm)
THTJ534121	305 (12")

Corta vidrios

178mm

INDUSTRIAL



Código	Medida
THT561781	178mm

Corta vidrios

130mm

INDUSTRIAL



Mango de madera
Posee 6 cuchillas de ruedas



Código	Medida
THT561301	130mm

Corta vidrios tipo T

120 x 45cm

INDUSTRIAL



Cuchilla YD05
Polea de nailon
Calibración
Tratamiento contra la oxidación



Código	Medida
TGCT11201	120 x 45 cm

Compás cortador de vidrios

600mm

INDUSTRIAL



Ventosas de goma
Regla de metal con escala
Incluye 6 cuchillas YG6X

Código	Diámetro corte
TGCT16001	60cm

Ventosa

115mm

INDUSTRIAL



Material ABS
Fuerza máxima portante 25kg

Código	Diámetro
TSP01251	115mm

Ventosa doble

115mm

INDUSTRIAL



Material ABS
Fuerza máxima portante 50kg

Código	Diámetro
TSP02501	115mm

Cortador de tubo de cobre y aluminio

3 - 32mm

INDUSTRIAL

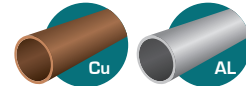
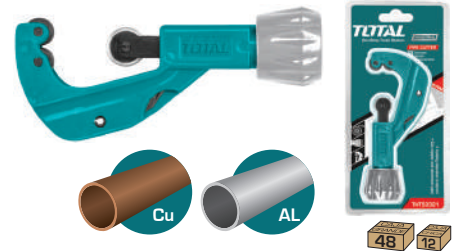

Código	Diámetro de corte
THT53321	3 - 32mm

Cortador de tubo de PVC

3 - 35mm



4Cr13



Código	L (mm)	Diámetro de corte
THT53351	210	3 - 35mm

Cortador de tubo de PVC

3 - 42mm



Código	L (mm)	Diámetro de corte
THT53422	225	3 - 42mm

Cortador de tubo de PVC

3 - 42mm



4Cr13



SUPER SELECT

Código	L (mm)	Diámetro de corte
THT534216	193	3 - 42mm

Cortador de tuberías

14 - 63mm

INDUSTRIAL

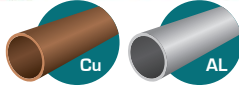

18

Código	Diámetro de corte
THT531463	14 - 63mm

Remachadora

10.5"



Ø2.4-3.2-4-4.8mm

24 4



Código	L	Remaches Ø (mm)
THT32108S	10.5"	2.4, 3.2, 4, 4.8

Remachadora

8"

INDUSTRIAL



Acero inox. Ø2.4-3.2-4mm

Aluminio Ø2.4-3.2-4-4.8mm

24 4



Código	L	Remaches Ø (mm)
THT32081	8"	2.4, 3.2, 4, 4.8

Remachadora

10"

INDUSTRIAL



Ø2.4-3.2-4-4.8mm

24 4



Código	L	Remaches Ø (mm)
THT32101	10"	2.4, 3.2, 4, 4.8

Remachadora

10.5"

INDUSTRIAL



Cuerpo de Aluminio

24 4



Código	L	Remaches Ø (mm)
THT32105	10.5"	2.4, 3.2, 4, 4.8

Remachadora de cabeza giratoria 360°

10.5"

INDUSTRIAL



360°

24 6



Código	L	Remaches Ø (mm)
THT32106	10.5"	2.4, 3.2, 4, 4.8

Remachadora

13"

INDUSTRIAL



Acero inoxidable: Ø 3.2, 4.0, 4.8, 6.0mm
Aluminio y acero: Ø 3.2, 4.0, 4.8, 6.0, 6.4mm



Código	L	Remaches Ø (mm)
THT32131	13"	3.2, 4, 4.8, 6.0

Remachadora

17"

INDUSTRIAL



20 1



Código	L	Remaches Ø (mm)
THT32176	17"	3.2, 4, 4.8

Remachadora plegable

32"

INDUSTRIAL

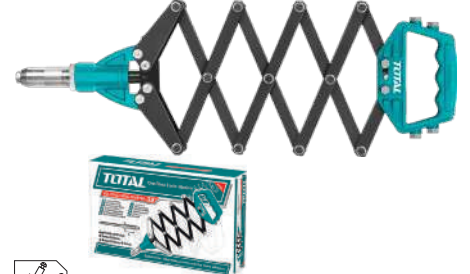

Código	L	Remaches Ø (mm)
THT32321	32"	3.2, 4, 4.8, 6, 6.4

Cortador hidráulico

315mm

INDUSTRIAL



Ø 4 - 12mm²

45KN

Código	Presión	Corte Ø (mm)
THSC012	45KN	4 - 12mm

Cortador hidráulico

480mm

INDUSTRIAL



Ø 4 - 22mm²

100KN

Código	Presión	Corte Ø (mm)
THSC022	100KN	4 - 22mm

Prensa hidráulica

4 - 70mm²

INDUSTRIAL



Cu4 - 70mm²

45KN

Corte: 11mm

Código	Presión	Tamaño
THCT070	45KN	11mm

Cuchilla para cortador h. 12mm/22mm INDUSTRIAL



Código	Medida	Compatibilidad
THSCO12B	4 - 12mm	THSCO12
THSCO22B	4 - 22mm	THSCO22

Perforadora de cuero 32" INDUSTRIAL



Código	Tamaño de agujero Ø (mm)
THT3351	2.5, 3, 3.5, 4, 4.5, 5

Grapadora 4 - 14mm INDUSTRIAL



Código	Medida
THT311425	4 - 14mm

Grapadora 6 - 14mm INDUSTRIAL



• Incluye 1000 grapas
C:10.6mm o 11.3mm - W:1.2mm

Código	Medida
THT31142	6 - 14mm

Grapadora 3 en 1 INDUSTRIAL



• Incluye 200 grapas.

Código	Medida
THT31143	4 - 14mm

Grapas 8 - 10mm INDUSTRIAL



• Compatible con grapadora THT31142

Código	Medida	Ancho
THT3982	8mm	1.2mm
THT39102	10mm	1.2mm

Grapas 12mm INDUSTRIAL



• Compatible con grapadora THT31143

Código	Medida	Ancho
THT39124	12mm	1.2mm

Grapas 10mm INDUSTRIAL

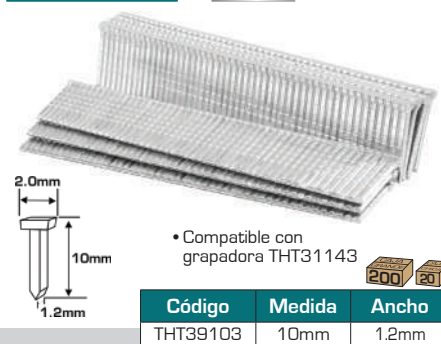

• Compatible con grapadora THT31143

Código	Medida	Ancho
THT39103	10mm	1.2mm

Llaves inglesas de combinación 8 pzas INDUSTRIAL

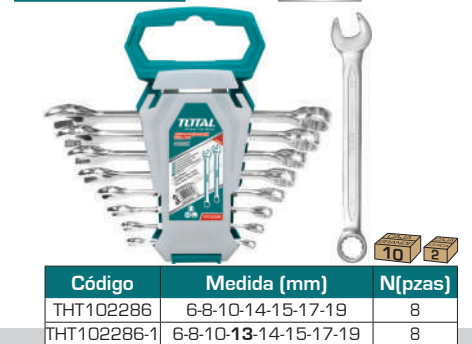

Código	Medida (mm)	N(pzas)
THT102286	6-8-10-14-15-17-19	8
THT102286-1	6-8-10-13-14-15-17-19	8

Llaves inglesas de anillo para tuerca 8 pzas INDUSTRIAL

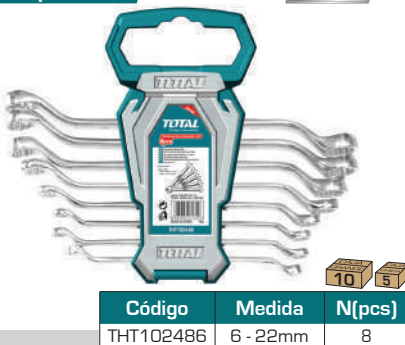

Código	Medida	N(pcs)
THT102486	6 - 22mm	8

Juego de llaves de combinación 8 pzas INDUSTRIAL



Código	Medida(mm)
THT102PK086	8 - 19

Llaves inglesas 8 pzas INDUSTRIAL



Código	Medida	N(pcs)
THT102386	6 - 22mm	8

Juego de llaves de combinación flexible

8 pzas

INDUSTRIAL

NEW



Código	Medida(mm)
THT102RK586	8 - 19

Juego de llaves de combinación

6 pzas

INDUSTRIAL



Código	Medida(mm)
THT102RK061	19 - 32

Juego de llaves de combinación

12 pzas

INDUSTRIAL



Código	Medida(mm)
THT1022121	6 - 24

Juego de llaves de combinación

12 pzas

INDUSTRIAL



Código	Medida(mm)
THT1022122	6 - 32

Juego de llaves de comb. doble

12 pzas

INDUSTRIAL



Código	Medida(mm)
THT1023121	6 - 32

Juego de llaves de anillo

12 pzas

INDUSTRIAL



Código	Medida(mm)
THT1024121	6 - 32

Llaves de combinación

1 pza

INDUSTRIAL



Código	Medida	Código	Medida
TCSPA061	6mm	TCSPA141	14mm
TCSPA081	8mm	TCSPA151	15mm
TCSPA101	10mm	TCSPA171	17mm
TCSPA121	12mm	TCSPA191	19mm
TCSPA131	13mm		

Llaves de combinación

1 pza

INDUSTRIAL

NEW



Código	Medida	Código	Medida
TCSPAR071	7mm	TCSPAR161	16mm
TCSPAR081	8mm	TCSPAR171	17mm
TCSPAR101	10mm	TCSPAR191	19mm
TCSPAR111	11mm	TCSPAR211	21mm
TCSPAR121	12mm	TCSPAR221	22mm
TCSPAR131	13mm	TCSPAR241	24mm
TCSPAR141	14mm		

Llaves de anillo de golpe

1 pza

INDUSTRIAL

NEW



Cr.V

Código	Medida
THT104032	32mm
THT104036	36mm
THT104041	41mm
THT104046	46mm
THT104050	50mm

Juego de llaves ajustables

3 pzas



6"
8"
10"

SUPER SELECT

Código	Medida(mm)
THTK1013	6", 8", 10"

Llave inglesa ajustable

6", 8", 10"

INDUSTRIAL



Cr.V

Ancha apertura

Código	L(mm)	Medida	caja grande	caja chica
THT101066	150mm(6")	24mm	60	6
THT101086	200mm(8")	30mm	36	6
THT101106	255mm(10")	35mm	24	6

Llave inglesa ajustable

12"

INDUSTRIAL



Cr.V

Ancha apertura

Código	L(mm)	Medida
THT101126	300mm(12")	41mm

Llave ajustable

6", 8", 10"

INDUSTRIAL



Ancha apertura

Código	L(mm)	Apertura	caja grande	caja chica
THT101063	150mm(6")	19.2mm	120	12
THT101083	200mm(8")	24mm	36	6
THT1010103	255mm(10")	30mm	24	4

Llave inglesa pico de loro

INDUSTRIAL

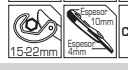

Código	Medida(mm)
THT10309328	9-14,15-22,23-32

Pata de cabra

24", 48"

INDUSTRIAL

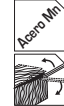
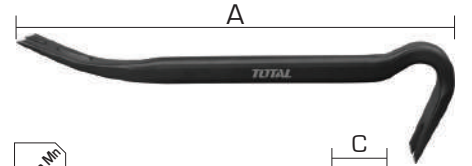

Código	A	B	C	caja grande	caja chica
THT431242	24"	1-1/8"	19/32"	6	6
THT431482	48"	1-1/8"	19/32"	4	4

Extractor de 2 mandíbulas

3" (2000kg)

INDUSTRIAL

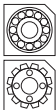

Código	Medida	Rango de aplicación	caja grande	caja chica
THTGP236	3"	A=80mm, L1=40mm, L2=44mm	10	10

Extractor de 3 mandíbulas

3" (3000kg)

INDUSTRIAL

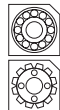

Código	Medida	Rango de aplicación
THTGP336	3"	A=75mm, L1=40mm, L2=47mm

Extractor de 2 mandíbulas

4" (3000Kg)

INDUSTRIAL



Código	Medida	Rango de aplicación	caja grande	caja chica
THTGP246	4"	A=115mm, A1=125mm, L1=40mm, L2=90mm, L3=39mm, L4=60mm	10	10
THTGP266	6"	A=180mm, A1=195mm, L1=50mm, L2=140mm, L3=50mm, L4=105mm	6	6

Extractor de 3 mandíbulas

4" (4000Kg)

INDUSTRIAL



Código	Medida	Rango de aplicación	caja grande	caja chica
THTGP346	4"	A=120mm, A1=125mm, L1=40mm, L2=87mm, L3=38mm, L4=60mm	10	10
THTGP366	6"	A=175mm, A1=170mm, L1=50mm, L2=135mm, L3=50mm, L4=95mm	6	6

Llave Allen hexagonal

9 pzas

INDUSTRIAL

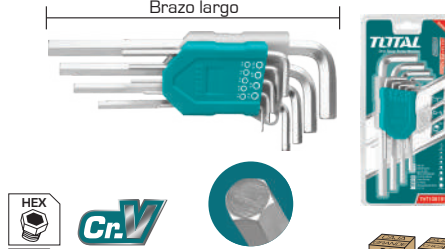

Código	Medidas	Descripción
THT106191	1.5 - 10mm	Brazo largo

Llave torx

9 pzas

INDUSTRIAL



Código	Medidas	Descripción
THT106392	T10 - T50mm	Brazo largo

Llave Allen hexagonal

9 pzas

INDUSTRIAL



Código	Medidas	Descripción
THT106192	1.5 - 10mm	Brazo extra largo

Llave torx

9 pzas

INDUSTRIAL



Código	Medidas	Descripción
THT106391	T10 - T50mm	Brazo extra largo

Llave Allen hexagonal

8 pzas

INDUSTRIAL



Código	Medida(mm)
THT1061826	2 - 8mm

Llave torx

8 pzas

INDUSTRIAL



Código	Longitud(mm)
THT1061846	T9-T40

Juego de llaves hexagonales y torx

18 pzas

INDUSTRIAL

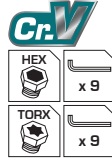

Código	Hex. 9pcs	Torx 9pcs	Descripción
THT106KT0181	1.5 - 10mm	T10-T50	Brazos extra largos

Llave ratchet

1/4"

INDUSTRIAL



Código	Dientes	Medida
THT106146	45T	1/4"

Llave ratchet 2 en 1

1/4", 3/8"

INDUSTRIAL



Código	Dientes	Medida
THT1061438	45T	3/8"

Llave ratchet

3/8", 1/2"

INDUSTRIAL



Código	Dientes	Medida	caja grande	caja chica
THT106386	45T	3/8"	40	10
THT106126	45T	1/2"	20	5

Ratchet telescópico

1/2"

INDUSTRIAL



Código	Dientes	Medida
THT106128L	72T	1/2"

Llave ratchet

3/4"

INDUSTRIAL



Código	Longitud
THT106346	20" (500mm)

Juego de llaves hexagonales con mango T

8 pzas

INDUSTRIAL



Código	Medidas
THHW80816	2x100, 2.5x100, 3x100, 4x150, 5x150, 6x150, 8x200, 10x200

Llave hexagonal con mango T

3x100, 4x100
5x150, 6x150

INDUSTRIAL

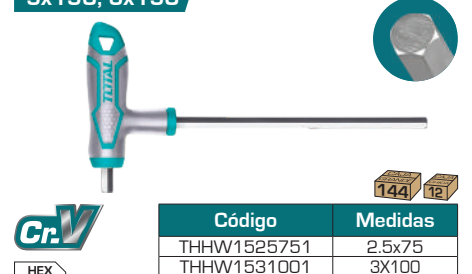

Código	Medidas
THHW1525751	2.5x75
THHW1531001	3x100
THHW1541001	4x100
THHW1551501	5x150
THHW1561501	6x150

Juego de llaves torx con mango T

8 pzas

INDUSTRIAL

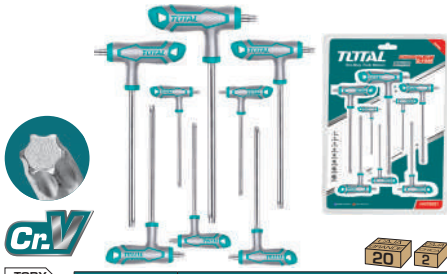

Código	Medidas
THHW8083	T10x75, T15x75, T20x100, T25x100, T30x150, T40x150, T45x200, T50x200

Juego de llaves torx con mango T

8 pzas

INDUSTRIAL



Código	Medidas
THHW80836	T10x75, T15x75, T20x100, T25x100, T30x150, T40x150, T45x200, T50x200

Llave torx con mango T

T20x100
T25x100
T30x150

INDUSTRIAL

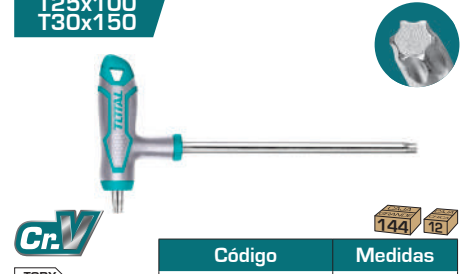

Código	Medidas
THHW15T201001	T20X100
THHW15T251001	T25X100
THHW15T301501	T30X150

Juego de llaves en L

9 pzas

INDUSTRIAL

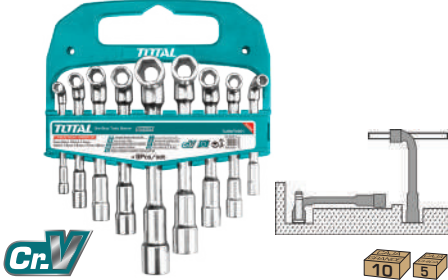

Código	Medidas (mm)	N(pzas)
TLASWT0901	7, 8, 10, 11, 12, 13, 14, 17, 19	9

Llave L

1/2"

INDUSTRIAL

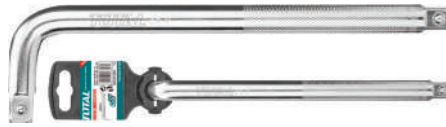

1/2"

Cr-V 50BV30

Código	Longitud
THLHD12121	12" (300mm)

Llave de barra para socket

1/2"

INDUSTRIAL

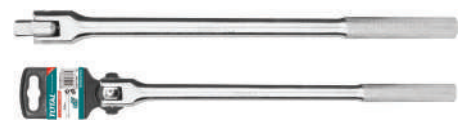

1/2"

Cr-V 50BV30

Código	Longitud
THTFX12151	15" (375mm)

Llave de barra para socket

3/4"

INDUSTRIAL



3/4"

Cr-V 50BV30

Código	Longitud
THTFX34201	20" (500mm)

Llave barra T deslizante

1/2"

INDUSTRIAL

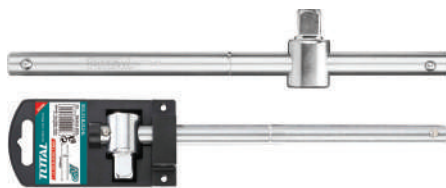

1/2"

Cr-V 50BV30

Código	Longitud
THTSTB12106	10" (250mm)

Llave barra T deslizante

3/4"

INDUSTRIAL



3/4"

Cr-V 50BV30

Código	Longitud
THTSTB34201	20" (500mm)

Torquímetro

1/2"

INDUSTRIAL



1/2"

Cr-V

Código	Rango
THPTW200N2	40 - 200 N.m

Torquímetro

1/2"

INDUSTRIAL

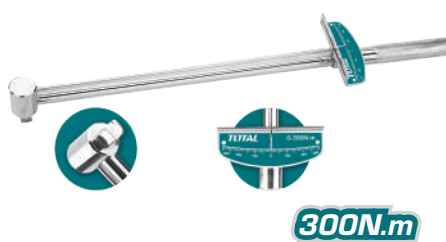

1/2"

Cr-V

Código	Rango
THPTW300N2	0 - 300 N.m

Llave Y para dados

8-10-12mm

INDUSTRIAL



Cr-V

Código	Largo	Medida
THYSW081012	145mm	8-10-12mm

Llave Y para dados

10-12-14mm

INDUSTRIAL



Cr-V

Código	Largo	Medida
THYSW101214	145mm	10-12-14mm

Llave cruceta

1/2"

INDUSTRIAL



1/2"

Código	Largo	Medida
THTRCW40231	16"	1/2"

Incluye 4 sockets:
17mm, 19mm,
21mm, 23mm.

Barra de extensión

1/2"

INDUSTRIAL



1/2"

Cr-V 50BV30

Código	Longitud	caja grande	caja chica
THEB12051	5" (127mm)	60	3
THEB12101	10" (255mm)	30	3

Socket Universal

1/2"

INDUSTRIAL



1/2"

Cr-V 50Bv30



Código	Longitud
THHUJ1121	73.5mm

Socket para bujía

1/2"

INDUSTRIAL



1/2"

Cr-V 50Bv30



Código	Medida
THSPS12166	16mm

Socket para bujía

1/2"

INDUSTRIAL



1/2"

Cr-V 50Bv30



Código	Medida
THSPS12216	21mm

Juego de socket 1/2"

3 pzas

INDUSTRIAL



1/2"



Código	Medida
THMLNS031	17, 19, 21mm

Juego de socket y llave L

10 pzas

INDUSTRIAL



1/2"

Cr-V 50Bv30



Código	Medida (mm)
THTL121101	10,12,13,14,17,19,21,22,24

Juego de socket tipo E

14 pzas

INDUSTRIAL



1/4"

Cr-V 50Bv30



Código	Medida (mm)
THKTETS0114	5 pzas 1/4" Socket: E4-5-6-7-8 5 pzas 3/8" Socket: E10-11-12-14-16 4 pzas 1/2" Socket: E18-20-22-24

Juego de socket

15 pzas

INDUSTRIAL



3/4"

Cr-V 50Bv30



Código	Medida (mm)
THT341151	10 pzas 3/4" socket: 30,32,34,36,38,41,46,50,55,60 1 llave ratchet 3/4" 24T 1 llave barra T deslizante 3/4" 520mm 1 barra de extensión 3/4" 100mm 1 barra de extensión 3/4" 200mm

Juego de socket

10 pzas

INDUSTRIAL



1/2"

Cr-V 50Bv30



Código	Medida (mm)
THT121101	10,11,12,13,14,15,17,19,21,24

Juego de socket de impacto 1/2"

10 pzas

INDUSTRIAL



1/2"

Cr-V 50Bv30



Código	Medida (mm)
THISTD12101	10,12,13,14,15,17,19,21,22,24

Juego de socket de impacto largos 1/2"

10 pzas

INDUSTRIAL



1/2"

Código	Medida (mm)
THKISD12102L	10,12,13,14,15,17,19,21,22,24

Socket hexagonal

1/2"

INDUSTRIAL



1/2"

Cr-V 50Bv30

Código	Medida(mm)	L(mm)
THTST12081	8	38
THTST12091	9	38
THTST12101	10	38

Socket hexagonal

1/2"

INDUSTRIAL



1/2"

Cr-V 50Bv30

Código	Medida(mm)	L(mm)
THTST12111	11	38
THTST12121	12	38
THTST12131	13	38

Socket hexagonal
1/2" INDUSTRIAL

Cr-V 50BV30

Código	Medida(mm)	L(mm)
THTST12141	14	38
THTST12151	15	38
THTST12161	16	38

Socket hexagonal
1/2" INDUSTRIAL

Cr-V 50BV30

Código	Medida(mm)	L(mm)
THTST12171	17	38
THTST12181	18	38
THTST12191	19	38

Socket hexagonal
1/2" INDUSTRIAL

Cr-V 50BV30

Código	Medida(mm)	L(mm)
THTST12201	20	38
THTST12211	21	38
THTST12221	22	38

Socket hexagonal
1/2" INDUSTRIAL

Cr-V 50BV30

Código	Medida(mm)	L(mm)
THTST12231	23	38
THTST12241	24	38

Socket hexagonal
1/2" INDUSTRIAL

Cr-V 50BV30

Código	Medida(mm)	L(mm)
THTST12251	25	41
THTST12261	26	41
THTST12271	27	43

Socket hexagonal
1/2" INDUSTRIAL

Cr-V 50BV30

Código	Medida(mm)	L(mm)
THTST12281	28	44
THTST12291	29	44
THTST12301	30	44
THTST12321	32	44

Socket hexagonal largo
1/2" INDUSTRIAL

Cr-V 50BV30

Código	Medida(mm)	L(mm)
THTST12083L	8	78
THTST12103L	10	78
THTST12113L	11	78

Socket hexagonal largo
1/2" INDUSTRIAL

Cr-V 50BV30

Código	Medida(mm)	L(mm)
THTST12123L	12	78
THTST12133L	13	78
THTST12143L	14	78

Socket hexagonal largo
1/2" INDUSTRIAL

Cr-V 50BV30

Código	Medida(mm)	L(mm)
THTST12153L	15	78
THTST12163L	16	78
THTST12173L	17	78

Socket hexagonal largo
1/2" INDUSTRIAL

Cr-V 50BV30

Código	Medida(mm)	L(mm)
THTST12183L	18	78
THTST12193L	19	78
THTST12203L	20	78

Socket hexagonal largo
1/2" INDUSTRIAL

Cr-V 50BV30

Código	Medida(mm)	L(mm)
THTST12213L	21	78
THTST12223L	22	78
THTST12243L	24	78

Socket hexagonal largo
1/2" INDUSTRIAL

Cr-V 50BV30

Código	Medida(mm)	L(mm)
THTST12273L	27	78
THTST12303L	30	78
THTST12323L	32	78

Socket de impacto

1/2"

INDUSTRIAL

NEW



CrMo

Cold extrusion

96

1/2" CrMo

Código	Medida(mm)	L(mm)
THDIS12101L	10	78
THDIS12121L	12	78
THDIS12131L	13	78

Socket de impacto

1/2"

INDUSTRIAL

NEW



CrMo

Cold extrusion

80

1/2" CrMo

Código	Medida(mm)	L(mm)
THDIS12141L	14	78
THDIS12151L	15	78
THDIS12161L	16	78

Socket de impacto

1/2"

INDUSTRIAL

NEW



CrMo

Cold extrusion

64

1/2" CrMo

Código	Medida(mm)	L(mm)
THDIS12171L	17	78
THDIS12191L	19	78
THDIS12211L	21	78

Socket de impacto

1/2"

INDUSTRIAL

NEW



CrMo

Cold extrusion

48

1/2" CrMo

Código	Medida(mm)	L(mm)
THDIS12221L	22	78
THDIS12241L	24	78
THDIS12271L	27	78

Adaptador para dado de impacto

1/2" - 3/4"

INDUSTRIAL

NEW



CrMo

80

1/2" 3/4" CrMo

Código	Medida(mm)
THIA1234	1/2"(F) X 3/4"(M)
THIA3401	3/4"(F) X 1"(M)

Socket hexagonal de impacto

3/4"

INDUSTRIAL

NEW



CrMo

20 4

3/4" CrMo

Código	Medida(mm)	L(mm)
THHISD3419L	19	90
THHISD3421L	21	90
THHISD3422L	22	90

Socket hexagonal de impacto

3/4"

INDUSTRIAL

NEW



CrMo

20 4

3/4" CrMo

Código	Medida(mm)	L(mm)
THHISD3423L	23	90
THHISD3424L	24	90
THHISD3427L	27	90

Socket hexagonal de impacto

3/4"

INDUSTRIAL

NEW



CrMo

20 4

3/4" CrMo

Código	Medida(mm)	L(mm)
THHISD3430L	30	90
THHISD3432L	32	90

Socket hexagonal de impacto

3/4"

INDUSTRIAL

NEW



CrMo

16 4

3/4" CrMo

Código	Medida(mm)	L(mm)
THHISD3433L	33	90
THHISD3434L	34	90
THHISD3436L	36	90

Socket hexagonal de impacto

3/4"

INDUSTRIAL

NEW



CrMo

16 4

3/4" CrMo

Código	Medida(mm)	L(mm)
THHISD3438L	38	90
THHISD3441L	41	90
THHISD3442L	42	90

Socket hexagonal de impacto

3/4"

INDUSTRIAL

NEW



CrMo

12 4

3/4" CrMo

Código	Medida(mm)	L(mm)
THHISD3446L	46	90
THHISD3448L	48	90

Socket hexagonal de impacto

1"

INDUSTRIAL

NEW



CrMo

20 4

1" CrMo

Código	Medida(mm)	L(mm)
THHISD0119L	19	90
THHISD0121L	21	90
THHISD0122L	22	90
THHISD0123L	23	90

Socket hexagonal de impacto

1"

INDUSTRIAL



CrMo

Código	Medida(mm)	L(mm)
THHISD0124L	24	90
THHISD0127L	27	90
THHISD0130L	30	90
THHISD0132L	32	90

1"

CrMo

Socket hexagonal de impacto

1"

INDUSTRIAL



CrMo

Código	Medida(mm)	L(mm)
THHISD0133L	33	92
THHISD0134L	34	92
THHISD0136L	36	92
THHISD0138L	38	92

1"

CrMo

Socket hexagonal de impacto

1"

INDUSTRIAL



CrMo

Código	Medida(mm)	L(mm)
THHISD0141L	41	92
THHISD0142L	42	92
THHISD0146L	46	95
THHISD0148L	48	95

1"

CrMo

Tecla de cadena

1T

INDUSTRIAL



Código	Carga	Altura	Peso	Fuerza
THT1611	1T	3m	9.5kg	322N

Catalina de cadena con palanca

0.75, 1.5T, 3T, 6T

INDUSTRIAL



THSLB6001 doble sola cadena

Código	Carga	Altura	Peso	Fuerza
THSLB0751	0.75T	1.5m	6.5kg	210N
THSLB1501	1.5T	1.5m	10.1kg	236N
THSLB3001	3T	1.5m	17.5kg	320N
THSLB6001	6T	1.5m	26kg	340N

Catalina de cadena

2T, 3T, 5T

INDUSTRIAL

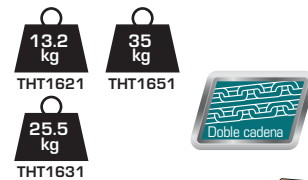

Código	Carga	Altura	Peso
THT1621	2T	3m	13.2kg
THT1631	3T	3m	25.5kg
THT1651	5T	3m	35kg

Catalina de cadena

5T

INDUSTRIAL



Código	Carga	Altura	Peso
TCBK0203	3T	3m	25.5kg
TCBK0205	5T	3m	42.5kg

Estación de soldadura de cautín estatio

60W

INDUSTRIAL



- Pre calentamiento: 1-2 minutos
- Temperatura ajustable
- Punta reemplazable de larga duración

Código	Potencia	Voltaje
UTET160911	60W	110-120V/60Hz

Bomba para desoldar

195mm

INDUSTRIAL



- Diámetro: 5.5 mm. Aluminio
- Diámetro de la bomba de estaño 20 mm

Código	Medida
TET518701	195mm

Bomba para desoldar

340mm

INDUSTRIAL



- Diámetro: 6.5 mm. ABS
- Diámetro de la bomba de estaño 26 mm

Código	Medida
TET534001	340mm

Soldador eléctrico

60W

INDUSTRIAL



- Pre calentamiento: 1-2 minutos
- Punta reemplazable

Código	Potencia	Voltaje
UTET160831	60W	110-120V/60Hz

Pistola de soldadura

90W

INDUSTRIAL



- Pre calentamiento: 20 seg
- Punta reemplazable

Código	Potencia	Voltaje
UTET160732	90W	110-120V/60Hz

Soldador eléctrico

60W

INDUSTRIAL



Calentador de masa de larga vida
Puntas de larga duración

Código	Potencia	Voltaje
UTET1606	60W	110-120V/60Hz

Cepillo de alambre

250mm

INDUSTRIAL



60 15

Código	Longitud
THT92102	250mm

Juego de cepillo de alambre

3 pzas

INDUSTRIAL



Código	Longitud
TAC38033	180mm

Tira línea de tiza

30m

INDUSTRIAL

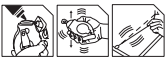

Código	Longitud
THT661301	30m

Cortador de azulejos

600mm

INDUSTRIAL

Mango cómodo



Corte máximo de 600mm

• Espesor de corte max. de 12mm

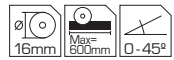

Código	Longitud
THT576004	600mm

Cortador de azulejos

INDUSTRIAL

800mm

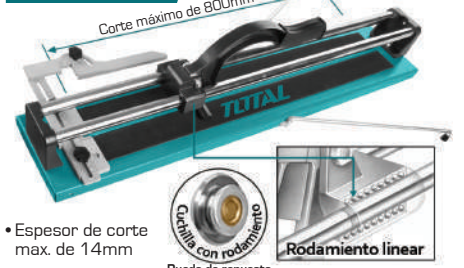

• Espesor de corte max. de 14mm

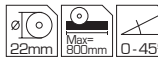

Código	Longitud
THT578004	800mm

Zunchos de nylon

100 pzas

INDUSTRIAL



1 AÑO DE GARANTÍA



Nylon 66

Código	Capacidad	c.grande
THTCT1001	100x2.5mm	500
THTCT15025	150x2.5mm	400
THTCT2001	200x3.6mm	200
THTCT3001	300x4.8mm	100
THTCT35048	350x4.8mm	100

Zunchos de nylon

100 pzas

INDUSTRIAL



1 AÑO DE GARANTÍA



Nylon 66

Código	Capacidad	c.grande
THTCT5001	400x7.2mm	50
THTCT45076	450x7.6mm	40
THTCT6001	600x9.0mm	24
THTCT72090	720x9.0mm	12

Zunchos de nylon

100 pzas

INDUSTRIAL



1 AÑO DE GARANTÍA



Nylon 66

Código	Capacidad	c.grande
THTCTB10025	100x2.5mm	500
THTCTB15025	150x2.5mm	400
THTCTB25048	250x4.8mm	120
THTCTB35048	350x4.8mm	100

Zunchos de nylon

100 pzas

INDUSTRIAL



1 AÑO DE GARANTÍA



Nylon 66

Código	Capacidad	c.grande
THTCTB45076	450x7.6mm	40
THTCTB55090	550x9.0mm	20
THTCTB72090	720x9.0mm	12
THTCTB80090	800x9.0mm	12

Brochas de pintar

9 pzas

INDUSTRIAL



24 4

Código	Medida
THT8414091	1"x3, 1.5"x2, 2.0"x2, 3.0"x1, 4.0"x1

Brochas de pintar

1", 1.5", 2"

INDUSTRIAL



Código	Ancho	Largo hebra	Espesor
THT84011	1"(25mm)	44mm	12.5mm
THT84151	1.5"(38mm)	44mm	13.5mm
THT84021	2"(50mm)	51mm	14.5mm

Brochas de pintar

2.5", 3", 4" **INDUSTRIAL**



Código	Ancho	Largo hebra	Espesor
THT84251	2.5"(63mm)	51mm	15.5mm
THT84031	3"(75mm)	57mm	16mm
THT84041	4"(100mm)	57mm	17.5mm

Brochas de pintar

1", 2", 3" **INDUSTRIAL**



Código	Ancho	Largo hebra	Espesor
THT845016	1"(25mm)	40mm	10mm
THT845026	2"(50mm)	45mm	11mm
THT845036	3"(75mm)	51mm	12mm

Juego de brochas 3 pzas

1", 2", 3" **INDUSTRIAL**



Código	Ancho
THT8450301	1", 2", 3"

Juego de brochas 8 pzas

1", 1.5", 2", 3", 4" **INDUSTRIAL**



Código	Ancho
THT8450801	1", 1.5", 2", 3", 4"

Brocha de pintar

5" **INDUSTRIAL**



Código	Ancho	Largo hebra	Espesor
THT84120306	5"(120mm)	70mm	28mm

Rodillo de pintar

230mm (9") **INDUSTRIAL**

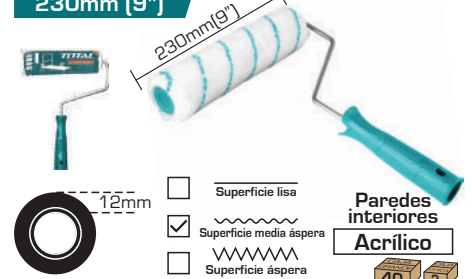

- Superficie lisa
- Superficie media áspera
- Superficie áspera

Paredes interiores
Acrílico

Código	Medida	Espesor	Ø(mm)	Modelo
THT8592	230mm(9")	12mm	6	Antiguo
THT8592D	230mm(9")	12mm	6	Mejorado

Rodillo de pintar

230mm (9") **INDUSTRIAL**



- Superficie lisa
- Superficie media áspera
- Superficie áspera

Paredes exteriores
Acrílico

Código	Medida	Espesor	Ø(mm)	Modelo
THT8593	230mm(9")	18mm	8	Antiguo
THT8593D	230mm(9")	18mm	8	Mejorado

Rodillo de pintar

255mm (10") **INDUSTRIAL**



- Superficie lisa
- Superficie media áspera
- Superficie áspera

Paredes exteriores
Acrílico

Código	Medida	Espesor	Ø (mm)
THT85101	255mm(10")	22mm	8

Rodillo de pintar

230mm (9") **INDUSTRIAL**

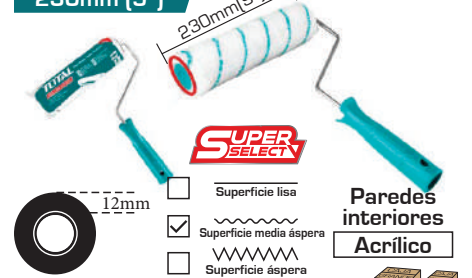

- Superficie lisa
- Superficie media áspera
- Superficie áspera

Paredes interiores
Acrílico

Código	Medida	Espesor	Ø (mm)
THT85096	230mm(9")	12mm	6

Cilindro para rodillo

230mm (9") **INDUSTRIAL**



Código	Medida	Largo
THTC8096	230mm(9")	320mm

Repuesto de rodillo

230mm (9") **INDUSTRIAL**

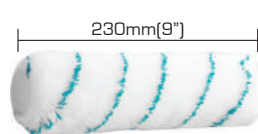

- Superficie lisa
- Superficie media áspera
- Superficie áspera

Paredes exteriores
Acrílico

Código	Medida	Espesor	Compatible
THT85931	230mm(9")	18mm	THT8593



Repuesto de rodillo
230mm (9") INDUSTRIAL **SUPER SELECT**

Altura fibra 12 mm
Micro fibra
Paredes interiores + Superficie media áspera

Código	Medida	Espesor	Compatible
THT85951	230mm(9")	12mm	THT8592

Repuesto de rodillo
255mm (10") INDUSTRIAL

255mm(10")
22mm

Superficie lisa
 Superficie media áspera
 Superficie áspera

Paredes exteriores
Acrílico

Código	Medida	Espesor	Compatible
THT851011	255mm(10")	22mm	THT85101

Rodillo de pintar INDUSTRIAL

230mm (9")

Código antiguo THT8594 / Código nuevo THT8594D

Superficie lisa
 Superficie media áspera
 Superficie áspera

Paredes interiores
Acrílico

Código	Medida	Espesor	Ø (mm)
THT8594	230mm(9")	7mm	6

Varilla telescópica
200cm INDUSTRIAL

2000mm
1100mm

Material de aluminio.

AL

Código	Medida
THTEP0205	200cm

Rodillo chico 12 en 1
100mm (4") INDUSTRIAL

10 repuestos

12mm

Superficie lisa
 Superficie media áspera
 Superficie áspera

Pared interior
Acrílico
Espuma de poliéster

Código	Medida	Espesor	Ø(mm)
THT81121001	100mm(4")	12mm	6

Mini rodillo para pintar
100mm (4") INDUSTRIAL

100mm(4")
12mm

Código antiguo THT8541 / Código nuevo THT85046

Superficie lisa
 Superficie media áspera
 Superficie áspera

Pared interior
Acrílico

Código	Medida	Espesor	Ø(mm)	Modelo
THT8541	100mm(4")	12mm	6	Antiguo
THT8541D	100mm(4")	12mm	6	Mejorado

Mini rodillo para pintar
100mm (4")

100mm(4")
12mm

Superficie lisa
 Superficie media áspera
 Superficie áspera

Pared interior
Acrílico

Código	Medida	Espesor	Ø(mm)
THT85046	100mm(4")	12mm	6

Repuesto de rodillo
100mm (4") INDUSTRIAL

100mm(4")
12mm

Superficie lisa
 Superficie media áspera
 Superficie áspera

Paredes interiores
Acrílico

Código	Medida	Espesor	Compatible
THT85431	100mm(4")	12mm	THT8541

Rodillo telescópico para pintar
230mm (9") INDUSTRIAL

230mm(9")
12mm

Superficie media áspera

Paredes interiores
Micro fibra

Código	Medida	Espesor	Ø(mm)
THT8592T	230mm(9")	12mm	8

Set de rodillo 3 en 1
230mm (9")

405mm
300mm

60kg

Código antiguo THT81122301 / Código nuevo THT811223041

Superficie lisa
 Superficie media áspera
 Superficie áspera

Paredes interiores
Acrílico

Código	Medidas	Espesor de fibra
THT81122301	230mm(9")	12mm

Set de rodillo 8 en 1 INDUSTRIAL

435mm
300mm

Acrílico

Superficie media áspera
 Superficie áspera

Paredes interiores y exteriores

Código	Especificaciones
THT811223081	Repuesto de rodillo: 1 pzas 230mm(9") x 7mm, 3 pzas 230mm(9") x 12mm, 1 pzas 230mm(9") x 18mm, Rodillo: 1 pzas 230mm(9"), Brocha: 1 pzas 255mm(10"), 1 bandeja para pintura, medida: 435x300x75mm

Bandeja para pintura
435x300x75mm INDUSTRIAL

Unidad de volumen en ml.
Esquinas redondeadas para verter fácilmente la pintura restante.
Extremadamente estable.

Código	Medida	Peso
TCHPTT082551	435x300x75mm	395g

Rodillo de pintar + bandeja
100mm (4")



Código	Medida	Repuestos
THT811210061	100mm/4"	4

Rodillo de pintar + bandeja
230mm (9")



Código	Medida	Repuestos
THT811223041	230mm/9"	2

Palustre de albañilería
180mm



Código	Medida
THT827125	180mm(7")

Palustre de albañilería
180mm, 200mm



Código	Medida
THT82716	180mm(7")
THT82816	200mm(8")

Palustre forjada tipo London
9", 10", 11", 12"



Código	Medida	Espesor
THT82098	9"	1.8mm
THT82108	10"	1.8mm
THT82118	11"	1.8mm
THT82128	12"	1.8mm

Palustre de albañilería
180mm



Código	Medida
THT82746	180mm(7")

Palustre de albañilería
200mm



Código	Medida
THT82826	200mm(8")

Llana de yeso
280x130mm



Código	Medida
THT81286	280x130mm

Llana de yeso con dientes
280x130mm



Código	Dientes	Medida
THT81286	10x10mm	280x130mm

Llana de yeso
230x100mm



Código	Medida
THT832306	230x100mm

Llana de yeso con dientes
230x100mm



Código	Dientes	Medida
THT832306	10x6mm	230x100mm

Llana de yeso
400x80mm



Código	Medida
THPTM40801	400x80mm

Espátula
60mm INDUSTRIAL



• Espesor 1.5mm

Código **Medida(mm)**
THT83606M 60

Diseño único Acero inoxidable

Espátula
60, 80, 100, 125mm INDUSTRIAL



Hoja especial

Código	Medida(mm)
THT83606	60
THT83806	80
THT831006	100
THT831256	125

Diseño único Acero inoxidable

Espátula
50mm, 63mm INDUSTRIAL

SUPER SELECT



Código	Medida(mm)
THT835026	50
THT836316	63

Espátula
63mm, 100mm INDUSTRIAL

SUPER SELECT



Código	Medida(mm)
THT836326	63 (2.5")
THT8310026	100 (4")
THT8312526	125 (5")

Espátula
75mm INDUSTRIAL



Código	Medida(mm)	Modelo
THT837526	75	Nuevo

Llana de goma para lechada
240x100mm INDUSTRIAL



Espesor: 19mm

Código	Medida(mm)
THT8324106	240x100

Llana de goma fina
230x100mm INDUSTRIAL



Base de goma espuma

Espesor: 15mm

Código	Medida(mm)
THT8320106	230x100

Bandeja de aluminio para drywall
300x300mm INDUSTRIAL



Espesor: 1.8mm

Código	Medida(mm)
THT833006	300x300 (12"x12")

Pistola calafateadora
9" INDUSTRIAL

NEW



Código	Espesor	Largo	Ø(mm)
THT21809	0.8mm	230mm	51

Pistola calafateadora
9" INDUSTRIAL

NEW



Código	Espesor	Largo	Ø(mm)
THT20409	1mm	230mm	55

Pistola calafateadora de aluminio
9" INDUSTRIAL

NEW



Para salchichas o cartuchos

Código	Ø(mm)	Medida
THT20109	54	230mm

Pistola calafateadora de aluminio
12" INDUSTRIAL

Placa de empuje más fuerte

Tirador extra fuerte

Diseño único TOTAL



Código	Ø(mm)	Medida
THT20112	51	12"

Pistola calafateadora

9"

INDUSTRIAL

Gancho

Giratorio

Tirador extra fuerte

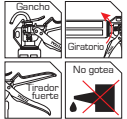

Código	Espesor	Largo	Medida
THT21509	1.8mm	230mm	9"

Pistola calafateadora

9"

INDUSTRIAL

Código antiguo | Código nuevo
THT20209 | THT21809



Código	Espesor	Largo	Ø(mm)
THT20209	0.8mm	230mm	55

Silicona

300ml

INDUSTRIAL



Código	Capacidad	Color
THT3511	300ml	Blanco
THT3512	300ml	Transparente
THT3513	300ml	Negro

Espátula para yeso

10", 16"

INDUSTRIAL



Código	Medida(mm)
THPUT78250	250mm (10")
THPUT78400	400mm (16")

Espátula para yeso

304mm (12")

INDUSTRIAL



Código antiguo | Código nuevo
THPUT28300 | THPUT38300

Código	Medida(mm)
THPUT28300	304mm (12")

Cubeta de plástico para drywall

305x120x90mm

INDUSTRIAL



Con limpiadores laterales de acero

Código	Medida(mm)
THPMP3501	305x120x90

Super pegamento

12 pzas

INDUSTRIAL

Secado en 10 seg



Código	Color	Peso	Piezas
THT3521	Transparente	3g	12

Escalera

INDUSTRIAL

260x250mm

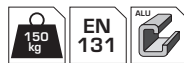

Código	Escalones
THLAD06031	3

Alt. de escalón	Carga
233mm(9")	150kg



Escalera

INDUSTRIAL

260x250mm



Código	Escalones
THLAD06051	5

Alt. de escalón	Carga
233mm(9")	150kg



Escalera

INDUSTRIAL

260x250mm



Código	Escalones
THLAD06071	7

Alt. de escalón	Carga
233mm(9")	150kg



Escalera

INDUSTRIAL

260x250mm

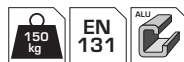

Código	Escalones
THLAD06091	9

Alt. de escalón	Carga
233mm(9")	150kg



Escalera de 3 secciones

INDUSTRIAL

Largo total 5.92m



Código	Escalones
THLAD03391	3x9

Alt. de escalón	Carga
280mm(11")	150kg



Escalera multipropósito de aluminio

INDUSTRIAL

EN 131

4x3 pasos

150 kg



4x3 steps

Código	Pasos	Alt. de escalón	Largo
THLAD04431	4x3	270mm(10.3/5")	3.38m

Escalera multipropósito de aluminio

INDUSTRIAL

EN 131

4x4 pasos

150 kg



4x4 steps

Código	Pasos	Alt. de escalón	Largo
THLAD04441	4x4	28cm	4.75m

Escalera de 2 peldaños de acero

INDUSTRIAL



380x260mm

150 kg



Código	Escalones
THLAD09021	2

Distancia paso	Carga
380x260mm	150kg

Escalera de 3 peldaños de acero

INDUSTRIAL



380x260mm

150 kg



Código	Escalones
THLAD09031	3

Distancia paso	Carga
380x260mm	150kg

Escalera de 4 peldaños de acero

INDUSTRIAL



380x260mm

150 kg



Código	Escalones
THLAD09041	4

Distancia paso	Carga
380x260mm	150kg

Escalera de 5 peldaños de acero

INDUSTRIAL



380x260mm

150 kg



Código	Escalones
THLAD09051	5

Distancia paso	Carga
380x260mm	150kg

Escalera de 6 peldaños de acero

INDUSTRIAL



380x260mm

150 kg



Código	Escalones
THLAD09061	6

Distancia paso	Carga
380x260mm	150kg

Escalera de tijera aluminio 5 pasos 1.3 mts

INDUSTRIAL



252mm

150 kg



Código	Escalones
THLAD01051	5

Distancia paso	Carga
252mm	150kg

Escalera de tijera aluminio 6 pasos 1.5 mts

INDUSTRIAL



252mm

150 kg



Código	Escalones
THLAD01061	6

Distancia paso	Carga
252mm	150kg

Escalera de tijera aluminio 7 pasos 1.8 mts

INDUSTRIAL



252mm

150 kg



Código	Escalones
THLAD01071	7

Distancia paso	Carga
252mm	150kg

Escalera de tijera aluminio 8 pasos 2.04 mts

INDUSTRIAL



252mm

150 kg



Código	Escalones
THLAD01081	8

Distancia paso	Carga
252mm	150kg

Escalera telescópica

INDUSTRIAL

6steps

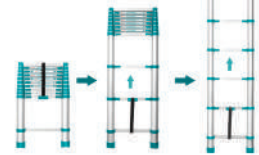

150 kg



EN 131

6 pasos



Código	Pasos	Alt. de escalón	Largo
THLAD08061	6	30cm	1.98m

Escalera telescópica



Código	Pasos	Alt. de escalón	Largo
THLAD08121	12	30cm	3.78m

Carretilla



Código	Carga(kg)	Capacidad de agua(L)
THTWB84010-1D	130	65
Rueda	LxHxCxAxBxH (mm)	
16"x4.00-8	1440x550x550x830x680x230	

Carretilla



Código	Carga(kg)	Capacidad de agua(L)
THTWB84018G	150	90
Rueda	LxHxCxAxBxH (mm)	
16"x4.00-8	1440x610x595x860x600x280	

Rueda neumática

16"



Código	Carga (kg)	Rueda
THTWB84008-P	130	16"x4.00-8

Adecuado para THTWB84010-1D

Rueda sólida

16"



Código	Carga (kg)	Rueda
THTWB84008-1DW	130	16"x4.00-8

Adecuado para THTWB84010-1D

Rueda neumática

16"

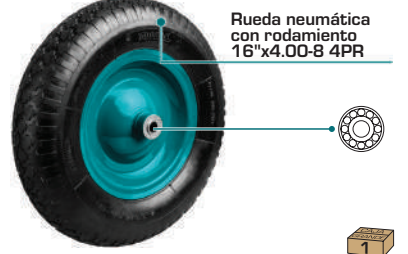

Código	Carga (kg)	Rueda
THTWB84018G-W	150	16"x4.00-8

Adecuado para THTWB84018G

Rueda de espuma PU sólida

16"

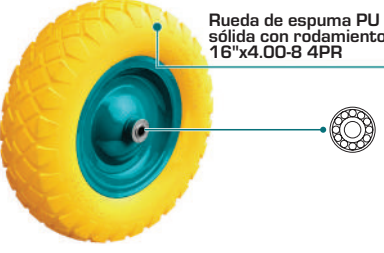

Código	Carga (kg)	Rueda
THTWB64018GPU-W	150	16"x4.00-8

Adecuado para THTWB84018G

Carretilla de plataforma plegable

150kg, 300kg



Código	Carga	Medida
THTHP11502	150kg	H820xh135xL725xW472mm
THTHP13002	300kg	H850xh195xL907xW608mm

Carretilla

150kg, 200kg



Código	Carga	Espesor de lámina
THTHT20221	150kg	3.5mm
THTHT20141	200kg	3.5mm

Rueda neumática

10"



Código	Carga (kg)	Rueda
THTHT20141-WP	100	10"x3.50-4

Adecuado para THTHT20221, THTHT20141

Transpaleta manual

2500kg



Código	Capacidad	Tamaño de tenazas
THT301251	2500kg	550x1150mm

Transpaleta manual

3000Kg



Código	Medida de paleta	Altura de uña
THT302301	685x1220mm	74 -190mm

Carretilla
200kg **INDUSTRIAL**

Espesor de tubo 1.2x25mm
Rueda neumática 10x3.50-4
Espesor de 3.5mm

Código	Carga	Espesor de lámina
THTHT20771	200kg	3.5mm

Carretilla 2 en 1
120kg **INDUSTRIAL**

Espesor de tubo 1.2x25mm
Rueda neumática 10x3.50-4
Espesor de 3.5mm

Código	Carga	Espesor de lámina
THTHT20751	120kg	3.5mm

Carretilla de 3 ruedas
200kg **INDUSTRIAL**

Espesor de tubo 1.2x25mm
Rueda sólida 6x1.5"
Espesor de 3.5mm

Diseño de 3 ruedas
Para facilitar el movimiento sobre obstáculos, umbrales y escaleras.

Código	Carga	Espesor de lámina
THTHT20461	200kg	3.5mm

Tijera de podar
205mm (8") **INDUSTRIAL**

Max Ø15mm

AL Handle Soft TPR MAX Ø15mm

Código	Medida(mm)
THT0109	205

Tijera de podar
220mm (8.5") **INDUSTRIAL**

Max Ø16mm

AL Handle Soft TPR MAX Ø16mm

Código	Medida(mm)
THT0601	220

Tijera de podar
205mm (8") **INDUSTRIAL**

Max Ø15mm

AL Handle Soft TPR MAX Ø15mm

Código	Medida(mm)
THT15308	205

Tijera de podar
200mm (8") **INDUSTRIAL**

Max Ø10mm

PP Handle Soft TPR MAX Ø10mm

Código	Medida(mm)
THT0201	200

Alicate para cercas de malla
250mm (10") **INDUSTRIAL**

36

Código	Medida(mm)
THT210102	250mm (10")

Alicate para cercas de malla
300mm (12") **INDUSTRIAL**

36

Código	Medida(mm)
THT210122	300mm (12")

Podador y sierra extensible
2800mm **INDUSTRIAL**

SK5
Espesor de sierra 1.2mm
MAX Ø25mm

Código	Medida(mm)
THEPS25281	2800

Tijera de podar
550mm (22") **INDUSTRIAL**

MAX 6mm

Tratamiento térmico Tratamiento de pulido MAX Ø 6mm

Código	Medida(mm)
THT1516201	550 (22")

Tijera de podar
580mm (22 7/8") **INDUSTRIAL**

12 6

Tratamiento térmico Tratamiento de pulido MAX Ø10mm

Código	Medida(mm)
THT1516001	580 (22 7/8")

Tijera de podar telescópica

710 - 860mm **INDUSTRIAL**



12 6

Código	Medida(mm)
THTS1516306	710 - 860

Tijera de podar

690mm (27")



10

Código	Medida(mm)
THT1527201	690 (27")

Tijera de podar

760mm (30") **INDUSTRIAL**



12 6

Código	Medida(mm)
THT1527401	760 (30")

Tijera de podar

760mm (30") **INDUSTRIAL**



12 6

Código	Medida(mm)
THT1527608	760 (30")

Tijera de podar telescópica

660 - 870mm **INDUSTRIAL**



12 6

Código	Medida(mm)
THTS1527416	660 - 870

Tijera de podar telescópica

655 - 890mm **INDUSTRIAL**



12 6

Código	Medida(mm)
THTA1527406	655 - 890

Tijera de podar

3 pzas

SUPER SELECT



6

Código	Medida
THT1578033	8" - 22" - 27"

Juegos de tijeras de podar

3 pzas

INDUSTRIAL



6

Código	Medidas
THT1576033	8.5", 22", 29"

Tijera para césped 340°

340mm (13 1/4") **INDUSTRIAL**



Peso 315g



24

Código	Medida(mm)
THTGS60340	340 (13 1/4")

Serrucho plegable

180mm (7") **INDUSTRIAL**



Corte rápido
Triple diente endurecido
Protección de corte



48 6

Código	Medida(mm)
THFSW1806	180 (7")

Sierra de podar

300mm (12") **INDUSTRIAL**

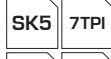

60 10

Código	Medida(mm)
THT5113006	300 (12")

Sierra de podar

330mm (13") **INDUSTRIAL**



60 10

Código	Medida(mm)
THT5113306	330 (13")

Sierra para podar
610mm (24") INDUSTRIAL



Incluye una hoja de sierra



Código	Medida(mm)
THT59241	610 (24")

Máquina de atado de plantas
12.5" INDUSTRIAL



Código	Medida(mm)
THTPTM1251	12.5"

Grapas para máquina atadora de plantas
10000 pzas INDUSTRIAL



7x4x0.55mm

10000PCS



Código	Medida(mm)
THTPTM1251S	7x4x0.55

Set de cinta de amarre para jardín extensible de 25m
20pzas / 25m



25M



25M

Código	Largo	Ancho
THTPTM1251T	25m	11mm

Boquilla para manguera de plástico
1/2"



ABS-TPR 1/2"

Código	Pulverización
THWS010901	9 formas

Boquilla para manguera de plástico
1/2"



ABS-TPR 1/2"

Código	Pulverización
THWS010301	3 formas

Boquilla para manguera de plástico
3/4"



Control continuo

ABS-TPR 3/4"

Código	Pulverización
THWSG6031	3 formas

Boquilla para manguera de plástico
3/4"



Control continuo

ABS-TPR 3/4"

Código	Pulverización
THWSG6091	9 formas

Juego de boquillas de 2 pzas
3/4"



ABS-TPR 3/4"

Código	Pulverización
THWSK0201	6 formas

Conector rápido
1/2"



ABS-PP 1/2"

Código	Medidas
THHCS01122	1/2"

Conector rápido
1/2"

Función detención de agua



ABS-PP 1/2"

Código	Medidas
THHCS01121	1/2"

Conector rápido
3/4"



ABS-PP 3/4"

Código	Medidas
THHCS63401	3/4"

Conector rápido

3/4"

Función detención de agua



ABS-PP 3/4"

Código	Medidas
THHCS63402	3/4"

120

Juego de conectores rápidos

3 pzas



ABS-TPR 1/2"

Código	Medidas
THWS030301	1/2"

48 4

Conector rápido de 2 vías

2 vías



ABS-PP 1"

Código	Medidas
THHC1202	1"

12

Juego de boquillas giratorias

5 pzas



ABS-TPR 1/2"

Código	Medidas
THHCS05122	1/2"

48 4

Conector de 4 vías

1" - 3/4"



ABS-PP 1" 3/4"

Código	Medidas
THHC604101	1" - 3/4"

24

Aspersor giratorio 3 brazos

3/4"



ABS-PP 3/4"

Código	Medidas
THPS23602	3/4"

48 4

Aspersor de torreta 5 en 1

3/4"



ABS 3/4"

Código	Medidas
THPS63022	3/4"

48 4

Aspersor tipo estaca 3 pines

3/4"

Función rotativa de 360°



ABS-PP 3/4"

Código	Medidas
THPS13601	3/4"

12

Temporizador de riego automático

8Bar / 116PSI

NEW



Max. 8 Bar
35L/min

35L/min IPX4

Código	Salidas (2)
THHCQ9206	3/4"

Manguera de agua

20m x 1/2", 50m x 3/4"



PVC

Código	Medidas
THPH2001	20m x 1/2"
THPH50341	50m x 3/4"

Manguera de agua

15m x 1/2"

NEW



Couplings de 3/4"

PVC

Código	Medidas
THPH151221	15m x 1/2"

Manguera de agua

15m x 5/8"

NEW



Couplings de 3/4"

PVC

Código	Medidas
THPH155821	15m x 5/8"

Carrete para manguera 40m

NEW



40M

Código	Capacidad
THHR40122	40m

Cubo plegable de PVC 250x320mm

NEW



15L

Código	Capacidad
TGTFB15	15L

Rociador 5L

5L



5L

Código	Capacidad
THSPP3051	5L

Rociador 8L

8L

NEW



8L

Código	Capacidad
THSPP3081	8L

Rociador 12L

12L

NEW



12L

Código	Capacidad
THSPP31201	12L

Rociador 16L

16L

NEW



16L

Código	Capacidad
THSPP41602	16L

Rociador 16L

16L

NEW



16L

Código	Capacidad
THSPP4161	16L

Rociador pulverizador 20L

20L

20L



20L

Código	Capacidad
THSPP4201	20L

Rociador pulverizador 20L

20L

NEW

20L



20L

Código	Capacidad
THSPP42002	20L

Rociador 2L

2L

Código antiguo THSPP202
Código nuevo THSPP2021



2L

Código	Capacidad
THSPP202	2L

Rociador 1.5L

1.5L

NEW



1.5L

Código	Capacidad
THSPP20151	1.5L

Rociador 1.5L

1.5L

NEW

1.5L



1.5L

Código	Capacidad
THSPP201502	1.5L

Rociador

2L

NEW



2L

2L

Código	Capacidad
THSPP20202	2L

20

Rociador

5L

NEW



5L

5L

Código	Capacidad
THSPP30502	5L

6

Regadera plástica

1.5L

NEW



1.5L

1.5L

Código	Capacidad
THSPP0155	1.5L

28

Regadera plástica

5L

NEW



5L

5L

Código	Capacidad
THSPP0505	5L

18

Regadera plástica

9L

NEW



9L

9L

Código	Capacidad
THSPP0905	9L

18

Grifo para lavamanos

158mm

10 años de garantía



Regulador de flujo confiable.
Cartucho de cerámica de alta calidad.
Cuerpo de metal de alta calidad.
Acabado cromado pulido.

Código	Altura total	Ø(mm)
TSLBM11501	158mm	45

8 1

Grifo para lavamanos

303mm

10 años de garantía



Regulador de flujo confiable.
Cartucho de cerámica de alta calidad.
Cuerpo de metal de alta calidad.
Acabado cromado pulido.

Código	Altura total	Ø(mm)
TSLBM12702	303mm	45

6 1

Grifo para fregador

361mm

10 años de garantía



Regulador de flujo confiable.
Cartucho de cerámica de alta calidad.
Cuerpo doblado de acero inoxidable.
Cuerpo de metal de alta calidad.
Acabado cromado pulido.

Código	Altura total	Ø(mm)
TSLBM23401	361mm	50

4 1

Grifo para ducha

150x192mm

10 años de garantía



Tamaño externo: 225x506x1710mm.
Manguera de acero inoxidable 1.5m.
Tubo de metal telescópico.
1 pieza de ducha de mano.
Regulador de flujo confiable.
Cartucho de cerámica de alta calidad.
Cuerpo de metal de alta calidad.
Acabado cromado pulido.

Código	Medida
TSLBM513681	150x192mm

1 1

Grifo para ducha

178x175x103mm

10 años de garantía



Regulador de flujo confiable.
Cartucho de cerámica de alta calidad.
Cuerpo de metal de alta calidad.
Acabado cromado pulido.

Código	Medida
TSLBM31001	178x175x103mm

8 1

Grifo para ducha

177x130mm

10 años de garantía



Regulador de flujo confiable.
Cartucho de cerámica de alta calidad.
Cuerpo de metal de alta calidad.
Acabado cromado pulido.

Código	Medida
TSLBM41201	177x130mm

8 1

Pala de jardinería

340mm



Ancho: 85mm
Espesor: 1.5mm

Código	Medida(mm)
THFT858	340

48

Tenedor para jardinería 320mm



Ancho: 80mm
Espesor: 2.5mm

48

Código	Medida(mm)
THFTF38	320

Rastrillo para jardinería 270mm



Ancho: 82mm
Varilla principal: 8mm

48

Código	Medida(mm)
THFR1008	270

Rastrillo para jardinería 290mm



Ancho: 75mm
Varilla principal: 8mm

48

Código	Medida(mm)
THGT979K	290

Machete cacha negra recto



Espesor de la hoja: 1.9 mm
Acero al carbono



Código	Medida
THMPH0112	12"
THMPH0114	14"
THMPH0116	16"
THMPH0118	18"
THMPH0120	20"
THMPH0122	22"
THMPH0124	24"
THMPH0126	26"

Machete Caguayano cabeza fina



Espesor de la hoja: 1.9 mm
Acero al carbono



Código	Medida
THMPS0222	22"
THMPS0224	24"
THMPS0227	27"

Segadora con mango de madera



Espesor de la hoja: 2.0 mm
Acero al carbono



Código	Medida
THSIW02121	12"
THSIW02141	14"
THSIW02161	16"

Rastrillo con mango 1200mm

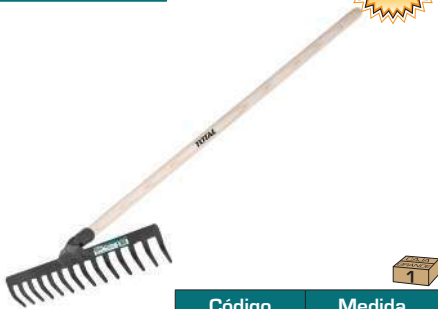

Código	Medida
THTHW0204	350x1200mm

Rastrillo sin mango 350x100mm



Código	Medida
THT1221	350x100mm

Trinche sin mango 330x220mm



Código	Medida
THT1231	330x220mm

Cabeza de azadón Ø 38x40mm



Peso 0.8Kg
Acero al carbono
No incluye mango

Código	Diámetro
THSH1081	38x40mm

Cabeza de azadón Ø 42x47mm



Peso 2.75 Lbs
Acero al carbono
No incluye mango

Código	Diámetro
THSH22751	42x47mm

Cabeza de azadón Ø 42x47mm



Peso 2.5 Lbs
Acero al carbono
No incluye mango

Código	Diámetro
THSH22502	42x47mm

Pala de acero
1020x215mm INDUSTRIAL

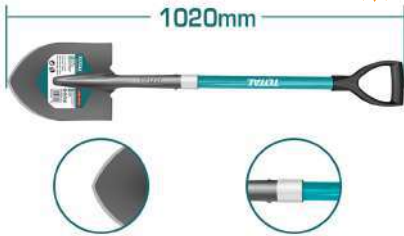

Código	L (mm)	Ancho (mm)	Peso
THTH12102	1020	215	1 kg

Pala de acero
1500x215mm INDUSTRIAL

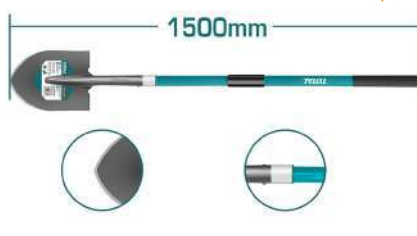

Código	L (mm)	Ancho (mm)	Peso
THTH12101	1500	215	1 kg

Pala de acero
1470x270mm INDUSTRIAL



Código	L (mm)	Ancho (mm)	Peso
THTHW0202	1470	270	1 kg

Pala de acero
1020x300mm INDUSTRIAL

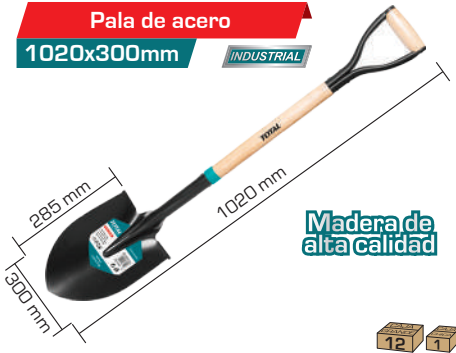

Código	L (mm)	Ancho (mm)	Peso
THTHW0101	1020	300	1 kg

Pala de acero
1030x240mm INDUSTRIAL

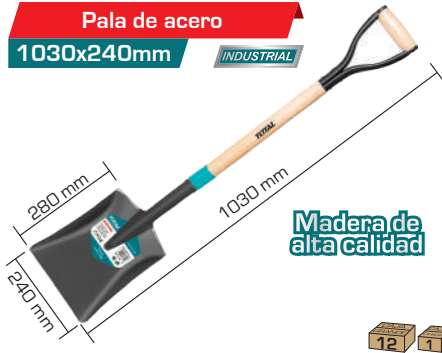

Código	L (mm)	Ancho (mm)	Peso
THTHW0102	1030	240	1 kg

Pala de acero
1030x270mm INDUSTRIAL



Código	L (mm)	Ancho (mm)	Peso
THTHW0103	1030	270	1 kg

Pala de acero
1450x215mm INDUSTRIAL



Código	L (mm)	Ancho (mm)	Peso
THTHW0201	1450	215	1 kg

Bolsa de herramientas
320x280mm INDUSTRIAL



Código	Medidas - Especificación
THT16P1011	L32xW28cm, 10 bolsillos para piezas, 2 soportes para martillos

Bolsa de herramientas
240x130mm INDUSTRIAL



Código	Medidas - Especificación
THT16P4011	L24xW13cm, 4 bolsillos para piezas, max. carga 5kg

Bolsa de herramientas
290x190mm INDUSTRIAL

Cinturón



Código	Medidas - Especificación
THT16P3011	L29xW19cm, 1 bolsillo para taladro inalámbrico, 5 bolsillos para piezas, max. carga 8kg

Bolsa de herramientas de cinturón
Polieste 600D INDUSTRIAL



Código	Medidas - Especificación
THT16P5021	Con dos portaobjetos, tres bolsas de destornillador y un soporte de correa de cinta

Caja de herramientas
495x200x290mm INDUSTRIAL



Código	Medida(mm)	Espesor de Acero
THT10701	495x200x290	0.6 - 0.8mm

Caja porta herramientas

14"x6.6"x6.3"

INDUSTRIAL



Código	Medidas - Especificación
TPBX0141	14"x6.6"x 6.3". Carga máxima:10KG, contiene 1pza bandeja de plástico

Caja porta herramientas

20"x11.7"x10.3"

INDUSTRIAL



Código	Medidas - Especificación
TPBX0201	20"x11.7"x 10.3". Carga máxima:20KG, contiene 1pza bandeja de plástico

Caja porta herramientas hebilla de metal

14"x6.6"x6.3"

INDUSTRIAL



Código	Medidas - Especificación
TPBX0142	14"x6.6"x 6.3". Carga máxima:10KG, contiene 1pza bandeja de plástico

Caja porta herramientas hebilla de metal

17"x8"x8.7"

INDUSTRIAL



Código	Medidas - Especificación
TPBX0172	17"x8"x 8.7". Carga máxima:15KG, contiene 1pza bandeja de plástico

Caja porta herramientas hebilla de metal

20"x11.7"x10.3"

INDUSTRIAL



Código	Medidas - Especificación
TPBX0202	20"x11.7"x 10.3". Carga máxima:20KG, contiene 1pza bandeja de plástico

Caja porta herramientas

17"x8.7"x8"

INDUSTRIAL



Código	Medidas - Especificación
TPBX0171	17"x8.7"x 8". Carga máxima:15KG, 3 áreas de almacenamiento

Bolsa de herramientas

16" - 21pzas

INDUSTRIAL



Código	Medidas - Especificación
THT36L01	16", 21 bolsillos para herramientas, max. carga 20kg

Chaleco para herramientas

42x60x3cm

INDUSTRIAL



Código	Medidas - Especificación
TTVT1601	42x60x3cm, 12 bolsillos para herramientas, max. carga 3kg

Bolsa para herramientas

16"

INDUSTRIAL



Código	Medidas - Especificación
THT36L02	16" Carga máxima: 20KG, 12 bolsillos para herramientas

Bolsa para herramientas

16"

INDUSTRIAL



Código	Medidas - Especificación
THT56161	16", Carga máxima: 20KG, 25 bolsillos para herramientas

Bolsa para herramientas

16"

INDUSTRIAL



Código	Medidas - Especificación
THT66L01	16", Carga máxima: 20KG, 14 bolsillos para herramientas

Bolsa para herramientas

20"

INDUSTRIAL



Código	Medidas - Especificación
THRRTB2001	20", Carga máxima: 20KG, 5 bolsillos internos

Bolsa de herramientas

16"

INDUSTRIAL



Base de plástico

Código	Medidas - Especificación
THT16161	16", bolsillos internos, Base de plástico reforzada, max. carga 20kg

Bolsa de herramientas

24"

INDUSTRIAL



Base de plástico

Código	Medida
THT16241	24"

Bolsa de herramientas

13", 16"

Código antiguo Código nuevo
THT26131 THT261325

SUPER SELECT



Código	Medida	Bols.	Carga	caja grande	caja chica
THT261325	13"	6	12kg	40	2
THT26131	13"	3	12kg	40	2
THT261625	16"	14	15kg	20	2

Bolsa de herramientas

18"x13.6"x6.8"

INDUSTRIAL



Código	Medida
THBP0201	18"x13.6"x6.8"

Llave de correa para filtro de aceite

9" - 12"

INDUSTRIAL

NEW



Código	Longitud	Sujeción
THTBPW0906	500mm	30 - 120mm
THTBPW1206	820mm	30 - 190mm

Llave de cadena para tubos

9" - 12"

INDUSTRIAL

NEW



Código	Longitud	Sujeción
THTCPW0916	520mm	60 - 180mm
THTCPW1216	420mm	60 - 130mm

Cama para mecánico

40"

INDUSTRIAL

NEW



Código	Peso	Medida
THACCO40	7.2kg	1025x425x110 mm

Cama plástica para mecánico

36"

INDUSTRIAL

NEW



Código	Peso	Medida
THCC036	5.76kg	920x425x95mm

Gato hidráulico para elevación de transmisiones

0.5Ton

INDUSTRIAL

NEW



Código	Capacidad	Altura
THT11005	0.5Ton	1140-1950mm

Prensa hidráulica

12T

INDUSTRIAL 12T

NEW



Código	Capacidad	Peso	Rango
THSPR1205	12T	42Kg	0-610mm

Prensa hidráulica

20T

INDUSTRIAL 20T

NEW



Código	Capacidad	Peso	Rango
THSPR2005	20T	66Kg	0-710mm

Prensa hidráulica

30T

INDUSTRIAL 30T

NEW



Código	Capacidad	Peso	Rango
THSPR3005	30T	122Kg	0-800mm

Gato hidráulico
2ton, 4ton, 10ton INDUSTRIAL



VÁLVULA DE SEGURIDAD

Código	Cap.	Rango[mm]	Peso	Caja grande	Caja chica
THT109022	2Ton	181-345	2.6kg	6	1
THT109042	4Ton	194-372	3.3kg	6	1
THT109102	10Ton	230-460	6.5kg	4	1

Gato hidráulico
12Ton, 20Ton INDUSTRIAL



VÁLVULA DE SEGURIDAD

Código	Capac.	Rango	Peso	Caja
THT109122	12Ton	235-470mm	6.7kg	3
THT109202	20Ton	240-460mm	8.7kg	2

Gato hidráulico
30Ton, 50Ton INDUSTRIAL



VÁLVULA DE SEGURIDAD

Código	Capacidad	Rango	Peso
THT109302	30Ton	285-465mm	22.3kg
THT109502	50Ton	300-480mm	32.2kg

Gato hidráulico
2.5Ton INDUSTRIAL **NEW**

Mango giratorio 360°



Código	Capacidad	Rango	Peso
THT108256	2.5Ton	89-360mm	14.2kg

Gato hidráulico
2Ton INDUSTRIAL



Código	Capacidad	Rango	Peso
THT10821	2Ton	140-340mm	8.7kg

Gato hidráulico
3Ton INDUSTRIAL



Código	Capacidad	Rango	Peso
THT10832	3Ton	135-410mm	16kg

Gato hidráulico perfil bajo
3Ton INDUSTRIAL

Bomba doble



Código	Capacidad	Rango	Peso
THT10834	3Ton	85-515mm	32kg

Gato hidráulico largo
5Ton, 10Ton INDUSTRIAL

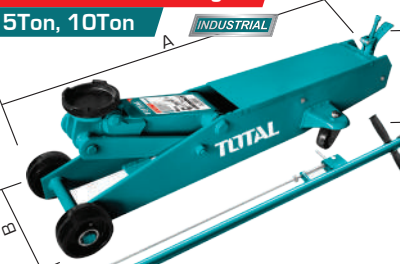

Código	Capacidad	Rango	Peso	Medida[AxBxC]
THT10805L	5Ton	150-560mm	87kg	1412x418x150mm
THT10810L	10Ton	160-560mm	127kg	1540x486x160mm

Soporte para gato
3Ton INDUSTRIAL



Código	Capacidad	Rango	Peso
THJS0301	3Ton	270-410mm	6.1kg

Pieza hidráulica para grúa de motor
2Ton INDUSTRIAL **NEW**



2 TON

Base Part

Rango de levantamiento 25-2000mm

Código	Capacidad
THT11021-1	2Ton

Pieza base para grúa de motor
2Ton INDUSTRIAL



2 TON

Hydraulic Part

Rango de levantamiento 25-2000mm

Código	Capacidad
THT11021-2	2Ton

Herramienta aplicadora de grasa
4500, 10000Psi INDUSTRIAL



Heavy duty

Código	Capacidad	Presión(Psi)
THT111051	400cc	4500-10000

Aplicador de grasa para taladro 4000, 8000Psi

INDUSTRIAL



- Cartucho de 14 oz
- Material de aluminio
- No incluye taladro
- Compatible con taladros inalámbricos, de impacto y eléctricos TOTAL



Código	Capacidad	Presión(Psi)
TGULI2001	400cc	4000-8000



Aplicador de grasa 3600, 6000Psi

INDUSTRIAL



- Heavy duty
- Cartucho de 21 oz
- Pistón doble
- Presión de trabajo:3600psi
- Presión de ráfaga:6000psi
- Tubo de acero 1.2mm + aluminio fundido



Código	Capacidad	Presión(Psi)
THT111062	600cc	3600-6000



Lubricador de grasa profesional de aire 30L

INDUSTRIAL

- Capacidad: 30L
- Relación de presión: 50: 1
- Dimensión de tanque: 330x430 mm
- Presión de trabajo: 6-8 bar
- Consumo de aire: 250L/min@6.2bar
- Velocidad de flujo máx.: 850g/min
- Manguera: 5M
- Peso: 16 kg

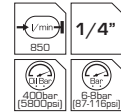

Código
THT118302



Bomba de aire de mano 80Psi

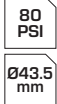

Código	Medida	Presión(Psi)
TMPP4501	Ø43.5x500mm	80



Bomba de aire de mano 160Psi

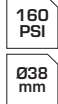

Código	Medida	Presión(Psi)
TMPP3811	Ø38x500mm	160



Bomba de aire de mano 160Psi



Código	Medida	Presión(Psi)
TMPP3201	Ø32x580mm	160

Aluminio



Bomba de aire de pie 120Psi



Código	Medida	Presión(Psi)
TMPP5511	Ø55x120mm	120



Compresor inalámbrico de auto 160Psi

INDUSTRIAL



- Presión máxima: 160PSI / 11 bar / 1100Kpa
- Max.flujo de aire: 35L / min
- Con luz LED 1PCS
- Con cable de 3M
- Con adaptador de bola 1pza
- Con adaptador de neumáticos
- Con adaptador para cama de aire



Código
TTAC1601

Compresor de auto 140Psi

INDUSTRIAL



Código
TTAC1406

Cargador de batería



- Carga baterías en 12 y 24V
- Selector para carga normal, carga rápida, inicio rápido

Código	Corriente	Peso
UTBC1601	110V/60Hz	5.6kg

Cable jumper para batería 600amp

INDUSTRIAL



- 3 mts de largo
- Para carros de menos de 4.5L

Código	Corriente	Pinza
PBCA16008L	600amp	18x11cm

Cable jumper para batería 200amp



- 2.5 mts de largo
- Para carros de menos de 1.8L

Código	Corriente	Pinza
PBCA12001	200amp	14x9cm

Cinta métrica de acero

3m x 16mm
5m x 19mm

SUPER SELECT



Centímetro y pulgadas

Función de bloqueo



Código	Medida
TMT37316	3m x 16mm
TMT37519	5m x 19mm

Cinta métrica de acero

3m x 16mm
5m x 19mm

SUPER SELECT



Centímetro y pulgadas

Código	Medida
TMT34316	3m x 16mm
TMT34519	5m x 19mm

Cinta métrica de acero

5m x 25mm
8m x 25mm

SUPER SELECT



Centímetro y pulgadas

Código	Medida
TMT34525	5m x 25mm
TMT34825	8m x 25mm

Cinta métrica de acero

2m x 13mm
3m x 16mm

INDUSTRIAL



Centímetro y pulgadas

Código	Medida
TMT126321	2m x 13mm
TMT126331	3m x 16mm

Cinta métrica de acero

5m x 19mm
5m x 25mm

INDUSTRIAL



Centímetro y pulgadas

Código	Medida
TMT126351	5m x 19mm
TMT126352	5m x 25mm

Cinta métrica de acero

3m x 16mm
5m x 25mm

INDUSTRIAL



Centímetro y pulgadas

Código	Largo(m)	Ancho(mm)	caja grande	caja chica
TMT126031	3	16	120	12
TMT126052	5	25	60	12

Innovado por TOTAL
Patent No: ZL 2015 3 0446164.2

Cinta métrica de acero

8m, 10m x 25mm

INDUSTRIAL



Centímetro y pulgadas



Métrica y pulgadas

Innovado por TOTAL
Patent No: ZL 2015 3 0446164.2

Código	Largo(m)	Ancho(mm)
TMT126081	8	25
TMT126101	10	25

Cinta métrica de acero

8m x 25mm

INDUSTRIAL



Centímetros

Métrica

Código	Medida
TMT126681M	8m x 25mm

Cinta métrica de acero

5m, 8m

INDUSTRIAL



Centímetro y pulgadas



Métrica y pulgadas

Código	Largo(m)	Ancho(mm)	caja grande
TMT126651	5	19	40
TMT126652	5	25	40
TMT126681	8	25	30

Cinta métrica de acero

3m x 16mm

INDUSTRIAL



Centímetro

Métrica

Código	Largo(m)	Ancho(mm)
TMT126231M	3	16

Cinta métrica de acero

3m x 16mm

INDUSTRIAL



Centímetro y pulgadas



Métrica y pulgadas

Código	Largo(m)	Ancho(mm)
TMT126231	3	16

Cinta métrica de acero

5m

INDUSTRIAL



Centímetro y pulgadas



Métrica y pulgadas

Código	Largo(m)	Ancho(mm)
TMT126251	5	19
TMT126252	5	25

Cinta métrica de acero

10m x 25mm

INDUSTRIAL

NEW



Centímetro y pulgadas



Métrica y pulgadas

Código	Largo(m)	Ancho
TMT1262101	10	25mm

Cinta métrica de acero

20m x 12.5mm

INDUSTRIAL

NEW



Métrica y pulgadas

Código	Largo(m)	Ancho(mm)
TMT11206	20	12.5

Cinta métrica de acero

20m x 12.5mm

INDUSTRIAL

• Auto enrollable 3:1

Innovado por TOTAL
Patent No. ZL 2015 3 0413145.X



3:1

Métrica y pulgadas

Código	Largo(m)	Ancho(mm)
TMTF12206	20	12.5

Cinta métrica de acero

30m x 12.5mm

INDUSTRIAL

Innovado por TOTAL
Patent No. ZL 2015 3 0413145.X

• Auto enrollable 3:1



3:1

Métrica y pulgadas

Código	Largo(m)	Ancho(mm)
TMTF13306	30	12.5

Cinta métrica de acero

50m

INDUSTRIAL

Innovado por TOTAL
Patent No. ZL 2015 3 0412812.2

• Auto enrollable 3:1



Métrica y pulgadas

3:1

Métrica y pulgadas

Código	Largo(m)	Ancho(mm)
TMT710506	50	12.5

Cinta métrica de acero

50m, 100m

INDUSTRIAL

NEW

• Auto enrollable 3:1



Métrica y pulgadas

3:1

Métrica y pulgadas

Código	Largo(m)	Ancho(mm)
TMTF13506	50	12.5
TMTF121006	100	12.5

Nivel de burbuja

30cm, 60cm

INDUSTRIAL

Innovado por TOTAL
Patent No. ZL 2015 3 0446227.4



0.5 mm/m



Esesor 1.5 mm

Código	Largo(cm)	Esesor
TMT2306	30	1.5mm
TMT2606	60	1.5mm

Nivel de burbuja

40cm

INDUSTRIAL

Innovado por TOTAL
Patent No. ZL 2015 3 0446227.4



0.5 mm/m



Diseño único TOTAL

Código	Largo(cm)	Esesor
TMT2406	40	1.5mm

Mini nivel de burbuja

22.5cm

INDUSTRIAL

Innovado por TOTAL
Patent No. ZL 2016 3 0244037.9



• Con imán



45°



Diseño único TOTAL

Código	Largo(cm)
TMT2235	22.5

Nivel de burbuja heavy-duty

24.5cm

INDUSTRIAL



x3



Código	Largo(cm)	Peso
TMT221306	24.5	315g

Nivel de burbuja

INDUSTRIAL

SUPER SELECT



Diseño único TOTAL



1.0 mm/m



Código	Largo(cm)	caja grande
TMT24036	40	40
TMT26036	60	40
TMT210036	100	20

Nivel de burbuja

INDUSTRIAL

Innovado por TOTAL
Patent No. ZL 2016 3 0312107.X



1.0 mm/m



Esesor 1.0 mm

Código	Largo(cm)	caja grande
TMT24016	40	40
TMT28016	80	20

Nivel de burbuja

40cm

INDUSTRIAL



Diseño único TOTAL

Código	Largo[cm]	Peso
TMT221406	40	450g

Nivel de burbuja

100cm

INDUSTRIAL

Innovado por TOTAL
Patent No: ZL 2015 3 0446227.4



Diseño único TOTAL

Código	Largo	Espesor
TMT21006	100cm	1.5mm

Nivel de burbuja

120cm

INDUSTRIAL

Innovado por TOTAL
Patent No: ZL 2015 3 0446227.4



Diseño único TOTAL

Código	Largo	Espesor
TMT21206	120cm	1.5mm

Nivel de burbuja

80cm, 150cm

INDUSTRIAL

Innovado por TOTAL
Patent No: ZL 2015 3 0446227.4



Espesor 1.5 mm

Código	Largo[cm]	caja grande
TMT28086	80	40
TMT215086	150	14

Nivel de burbuja

150cm

INDUSTRIAL



Diseño único TOTAL

Código	Largo	Imanes
TMT215056	150cm	6

Nivel de burbuja

200cm

INDUSTRIAL



Diseño único TOTAL

Código	Largo	Imanes
TMT220086	200cm	6

Nivel de burbuja

INDUSTRIAL

Código antiguo: TMT21205M, TMT21505M
Código nuevo: TMT212086M, TMT215086M



Magnético

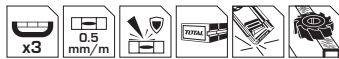

Código	L[cm]	Espesor	Imanes	caja grande
TMT20405M	40	1.5mm	2pzas	20
TMT26086M	60	1.5mm	3pzas	20
TMT210086M	100	1.5mm	4pzas	20
TMT21205M	120	1.5mm	5pzas	20
TMT21505M	150	1.5mm	6pzas	14

Nivel de albañil heavy - duty

60cm

INDUSTRIAL

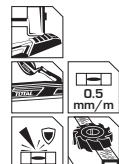

Código	Largo [cm]
TMT221606	60

Nivel digital

60cm

INDUSTRIAL

Innovado por TOTAL
Patent No: ZL 2016 3 0244037.9

Magnético



- Rango de medición: 0°~360° (4 * 90°)
- Precisión de medición: ± 0,2
- Potentes imanes: 3 piezas
- Fresado de doble cara

Código	Largo	Espesor
TMT2606D	60cm	1.5mm

Regla multiuso

60cm

INDUSTRIAL



Código	Largo	Material
TMT646003	60cm	Aluminio

Regla de aluminio anodizado

30cm

INDUSTRIAL



• Material: aluminio anodizado

Código	Largo	Ancho
TMT633002	30cm	3cm

Regla de aluminio anodizado

60cm

INDUSTRIAL



• Material: aluminio anodizado

Código	Largo	Ancho
TMT636002	60cm	5cm

Regla de aluminio
60cm INDUSTRIAL

• Ancho de la hoja: 40 mm
• Grosor de la hoja: 1.5 mm
• Hoja de acero inoxidable
• Mango de polímero de gran resistencia
• Punto de marcado para lápiz

Código	Largo [cm]
TMT222606	60

Ángulo escuadra
300mm (12") INDUSTRIAL

• Ancho de la hoja: 40 mm
• Grosor de la hoja: 1.5 mm
• Hoja de acero inoxidable
• Mango de polímero de gran resistencia
• Punto de marcado para lápiz

Código	Largo	Espesor
TMT61126	300mm	1.5mm

Ángulo con métrica y pulgada hasta 75°
150mm (7") INDUSTRIAL **NEW**

• Ancho de la hoja: 28 mm
• Grosor de la hoja: 1.2 mm
• Hoja de acero inoxidable
• Con burbuja niveladora

Código	Largo	Espesor
TAHS181511	150mm	1.2mm

Ángulo con métrica y pulgada hasta 75°
300mm (12") INDUSTRIAL **NEW**

• Ancho de la hoja: 30 mm
• Grosor de la hoja: 3.0 mm
• Hoja de acero inoxidable
• Con burbuja niveladora

Código	Largo	Espesor
TAHS3011	300mm	3.0mm

Ángulo escuadra
300mm (12") INDUSTRIAL

• Ancho de la hoja: 25 mm
• Grosor de la hoja: 2.0 mm
• Hoja de acero inoxidable
• Mango ajustable

Código	Largo	Espesor
TMT653005	300mm	2.0mm

Ángulo escuadra
7" x 7" INDUSTRIAL

• Ancho de la hoja: 25 mm
• Grosor de la hoja: 2.0 mm
• Hoja de acero inoxidable
• Mango ajustable

Código	Medida	Material
TMT61201	7" x 7"	ABS

Escuadra de Acero
170mm/270mm INDUSTRIAL **NEW**

• Resolución de pantalla: 0,1 m
• Pantalla digital y memoria
• Sistema dual métrico y en pulgadas
• Soporte
• Fuente de alimentación: baterías 2xLR3

Código	Medida	Material
TMT61205	170x120mm	Acero inox.
TMT61203	270x160mm	Acero inox.

Odómetro de rueda digital
320mm INDUSTRIAL **NEW**

• Valor de división: 0,1 kg
• Fuente de alimentación: baterías 3xAAA

Código	Tolerancia	Rango
TMT19923	< 5%	0 - 99999.9m

Báscula corporal
260 x 320mm INDUSTRIAL

• Valor de división: 0,1 kg
• Fuente de alimentación: baterías 3xAAA

Código	Rango	Medida	Unidad
TESA41801	0.2-180kg	260x320mm	Kg/Lb

Lapiz tester para Voltaje
140x3mm INDUSTRIAL **NEW**

• Resolución de pantalla: 0,1 m
• Pantalla digital y memoria
• Sistema dual métrico y en pulgadas
• Soporte
• Fuente de alimentación: baterías 2xLR3

Código	Lmm]	Voltaje
THT291408	140	AC 100-500V

Lapiz tester para Voltaje
190mm INDUSTRIAL

• Resolución de pantalla: 0,1 m
• Pantalla digital y memoria
• Sistema dual métrico y en pulgadas
• Soporte
• Fuente de alimentación: baterías 2xLR3

Código	Lmm]	Voltaje
THT291908	190	AC 100-500V



Lápiz de prueba digital

133mm

INDUSTRIAL



Código	Voltaje
THT1909	AC 12-250V / DC 1.5-36V

Lapiz tester para Voltaje

133x23x17 mm

INDUSTRIAL

NEW



Código	Voltaje
THT292201	AC100-500V / Digital: 12-220V

Lápiz de prueba digital

12 - 300V

INDUSTRIAL

NEW



Código	Voltaje
THT2930021	AC / DC 12 - 300V

Detector de voltaje de AC sin contacto

THT2910003

INDUSTRIAL



- Indicador de batería baja
- Luz LED

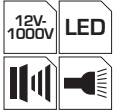

Voltaje AC	12V-1000V AC
Frecuencia	50Hz/60Hz
Modo alarma	Luz y sonido

Probador de voltaje automatizado

6 - 24V

INDUSTRIAL

NEW

- Diámetro 3 mm
- Mango aislado AS
- Viene con clip de lápiz eléctrico



Código	Voltaje
THT414501	6-24V

Probador de voltaje automatizado

1-100V

INDUSTRIAL

DC 1-100V



- Pantalla digital. Linterna
- Luz de Fondo
- Longitud máxima: 2700 mm

Código	Voltaje
THT417506	1-100V

Probador de líquido de frenos

0% ~ 4%

INDUSTRIAL

NEW



- Apagado automático
- Indicador de batería baja



Código	Rango
TETBF01	Rango: 0% ~ 4%

Multímetro digital

TMT460012



- 2000 dígitos

Voltaje DC	200mV/2V/20V/200V/600V
Voltaje AC	20V/200V/600V
Corriente DC	20mA/200mA/10A
Resistencia	200Ω/2kΩ/20kΩ/200kΩ/2MΩ/20MΩ

Multímetro digital

TMT460013



- 6000 dígitos RMS

Voltaje DC	60mV/600mV/6V/60V/600V/600V
Voltaje AC	60mV/600mV/6V/60V/600V/600V
Corriente DC	6000μA/60mA/600mA
Corriente AC	6000μA/60mA/600mA
Resistencia	600Ω/6kΩ/60kΩ/600kΩ/6MΩ/60MΩ
Capacitancia	6nF/60nF/600nF/6μF/60μF/600μF/6mF/60mF

Multímetro digital

TMT46001

INDUSTRIAL



Voltaje DC	200mV/2V/20V/200V/600V
Voltaje AC	200V/600V
Corriente DC	200μA/2mA/20mA/200mA/10A
Resistencia	200Ω/2kΩ/20kΩ/200kΩ/2MΩ

Multímetro digital

TMT47503

INDUSTRIAL



Voltaje DC	600mV/6V/60V/600V/1000V±(0.5%+3)		
Voltaje AC	6V/60V/600V/750V±(0.8%+3)		
Corriente DC	60μA/6mA/60mA/600mA±(0.8%+3), 10A±(1.2%+3)		
Resistencia	600Ω/6kΩ/60kΩ/600kΩ/6MΩ±(0.8%+3), 60MΩ±(1.0%+3)		
Corriente AC	Capacidad	Frecuencia	Ciclo de trabajo

Multímetro Digital TOTAL smart 600V

TMT460002

INDUSTRIAL

NEW



- AC/DC voltaje, resistencia y frecuencia
- Rango automático, retención de fecha

Multimetro Digital
TMT460011 INDUSTRIAL **NEW**

CAT III 600V

• 2000 dígitos

SMART 600kΩ
V~ V~
800V 800V

40

Multimetro Digital
TOTAL smart 1000V
TMT475052 INDUSTRIAL **NEW**

CAT. III 1000V

V~ V~ F
750V 1000V 1000mF
A~ A~ Ω
10A 10A 100MΩ

• AC/DC voltaje, resistencia y continuidad NCV
• Prueba en vivo, prueba de diodo, Medición relativa

30

Pinza Amperimétrica
6000 Cuentas
TMT410005 INDUSTRIAL **NEW**

AC/DC 1000A

A~ 1000A
V~ V~ Ω
750V 1000V 500Ω

• Retención de datos, Pinza amperimétrica CC/CA
• Frecuencia: 0 ~ 10KHz ± (1.5% +5)

20

Medidor de pinza digital
TMT42002 INDUSTRIAL

40 2

LCD

Voltaje DC	0.1-600V±(0.5% +5)
Voltaje AC	0.1-600V±(1.0% +5)
Corriente AC	2A/20A/200A/±(2.5% +8)
Resistencia	2kΩ/20kΩ±(1.0% +3)

Medidor de pinza digital
TMT46003 INDUSTRIAL

20 4

LCD

Voltaje DC	0.1-600V±(0.5% +3)
Voltaje AC	0.1-600V±(0.8% +5)
Corriente AC	6A/60A/600A/±(2.5% +8)
Resistencia	0-6kΩ±(0.8% +3)

Medidor de pinza digital
TMT46004 INDUSTRIAL

LCD AC/DC

20 4

• Diode test/True RMS/LPF

Voltaje DC	0.1-600V±(0.5% +3)
Voltaje AC	0.1-600V±(0.8% +5)
Corriente DC	60A/600A ±(2.5%+5)
Corriente AC	6A/60A/600A/±(2.5%+8)
Temperatura	40°C~1000°C(40°F~1832°F)±(1.0%+2)
Resistencia	6kΩ/60kΩ ±(1.0% +3)

Medidor de pinza digital
TMT410004 INDUSTRIAL

Código antiguo TMT410004 Código nuevo TMT4100041

20 5

LCD

Voltaje DC	60mV/600mV/6V/60V/600V/1000V
Voltaje AC	60mV/600mV/6V/60V/600V/750V
Corriente AC	60A/600A/1000A
Resistencia	600Ω/6kΩ/60kΩ/600kΩ/6MΩ/60MΩ

Cable de prueba

100 1

TMT423

Conector curvo negro y rojo
Moldeo por inyección secundario
Largo= 143mm
Compatible con TMT410002

Anemómetro digital
0.80 - 40.00 m/s INDUSTRIAL

• Rango de velocidad del aire 0.80-40.00m/s
• Resolución 0.01 ±(2.0%+30)
• Retención de datos
• Con función de retroiluminación
• Con función de indicación de la batería

LCD

20 4

Código	Rango
TETAN01	0.80-40.0 m/s

Indicador de gas digital
TETGA01 INDUSTRIAL

LCD

20 4

Rango	0~9999ppm (metano)
Detección	Gas combustible
Precisión	± 5% FS (metano)
Sensibilidad	≤50ppm (metano)
Sonda flexible	450mm
Tiempo de resp.	2 seg

Indicador de gas digital
TETGA23 INDUSTRIAL

LCD

80

Rango	50~1000ppm (metano)
Detección	Gas combustible
Sensibilidad	≤50ppm (metano)
Ambiente de uso	0-50°C/20-80%RH
Tiempo de resp.	≥500PPM: 5seg; ≥500PPM: 2seg
Alimentación	Baterías AAA de 2x1.5V

Medidor de humedad en madera digital
TETWM23 INDUSTRIAL

LCD

80

• Función de medición máxima y mínima
• Función de apagado automático
• Función indicadora de batería baja
• Parámetros característicos incorporados de 7 materiales de madera y construcción diferentes

Rango humedad	0 ~ 58%
Precisión humedad	±2%

Medidor de humedad en madera digital

TETWMO1

INDUSTRIAL



Rango humedad	2~70%
Precisión humedad	±2%
Rango temperatura	0~40°C
Precisión temperatura	±1°C
Humedad ambiental	20~90%RH
Temperatura ambiental	0~40°C

Medidor de humedad y termómetro digital

TETHT23

INDUSTRIAL



Temperatura ambiente	-20°C~60°C (-4°F~140°F)
Humedad ambiente	0~99%RH
Temperatura del bulbo	-20°C~60°C (-4°F~140°F)
Temp. de condensación	-50°C~60°C (-58°F~140°F)

Medidor de humedad y temperatura digital

TETHT01

INDUSTRIAL



Temperatura ambiente	-20°C~60°C (-4°F~140°F)
Humedad ambiente	0~100%
Temperatura del bulbo	-20°C~60°C (-4°F~140°F)
Temp. de condensación	-20°C~60°C (-4°F~140°F)

Medidor de sonido digital

TETSLO1

INDUSTRIAL



Rango de medición	30 - 130dB
Rango dinámico	50dB
Precisión de la presión acústica	±1.5dB(94dB@1KHz) ±1.5dB(94dB@8KHz)
Respuesta de frecuencia	30Hz - 8KHz

Luxómetro digital

TETLU01

INDUSTRIAL



Rango	0~200000 Lux (0~20000FC)
Resolución	1LUX/1FC
Precisión	±(3%+5Lux) (a 2854°K lámparas incandescentes) ±(6%+5Lux) otros
Caract. de la desviación del áng. coseno	30°(±2%) , 60°(±6%) , 60°(±2.5%)
Rango espectral	320-730nm

Calibrador Vernier

0 - 150mm



Código	Rango	Medición
TMT321506	0 - 150mm	0.01mm

Calibrador Vernier

0 - 150mm



SUPER SELECT



3V

Código	Rango	Medición
TMT331501	0 - 150mm	0.1mm

Calibrador Vernier

0 - 200mm

INDUSTRIAL



3V

Código	Rango	Medición
TMT312001	0 - 200mm	0.05mm

Detector de distancia láser

0.05 - 60m

INDUSTRIAL



Código	Rango	Precisión	Tipo de láser
TMT56016	0.05-60m	±2.0mm	620-690nm,<1mW,Class 2

Termómetro láser

-30°C~550°C

INDUSTRIAL



<0.5S

Código	Temperatura	Temp. ambiente
THIT015501	-30°C~+550°C (-22°F~+1022°F)	-10°C-60°C

Termómetro láser

32°C~42.9°C

INDUSTRIAL



1S

- Modo Humanos: 32°C~42.9°C.
- Modo industrial: -30°C - 550°C

Código	Temperatura	Margen de error
THIT010381	32°C-42.9°C -30°C~+550°C	±0.3°C

Termómetro láser

-30°C~450°C



SUPER SELECT

<0.5S

Código	Temperatura
THIT0155026	-30°C~+450°C (-22°F~+842°F)

Termómetro láser

32°C-42.9°C



SUPER SELECT



Código	Temperatura
THIT0103826	32°C-42.9°C

30

Trípode para nivel láser

INDUSTRIAL



1200mm

• Compatible con modelo TLL156506 / TLL306505



Código	Rosca	Peso	Altura
TLLT01152	5/8" - 1/4"	1kg	1.2m

9

Nivel láser

INDUSTRIAL

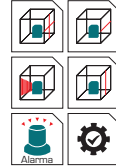

• Tiempo de nivelación: <4s
• Exactitud: ±1.5mm (at 5 m)
• Ángulo autonivelante: ≤4°

Código	Potencia	Rango
TLL156506	≤1mW	0-15m

20 2

Nivel láser

INDUSTRIAL

• Tiempo de nivelación: <3s
• Exactitud: ±1.5mm (at 5 m)
• Ángulo autonivelante: ≤4°

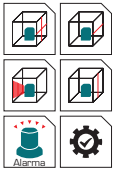
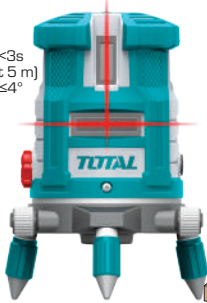

Código	Potencia	Rango
TLL306505	≤1mW	0-20m

8 1



Guantes de puntos de PVC

10 (XL)

INDUSTRIAL



- Usado para manipular mercancía, reciclajes, reparaciones etc.

Código	Calibre	Medida
TSP11102P-XL	10	10 (XL)

Guantes de nitrilo

10 (XL)

INDUSTRIAL



CE
EN388
4112

- Completamente revestido de nitrilo en palma y reverso
- Usado en ambientes con mucho aceite

Código	Medida
TSP12105	10(XL)

Guantes de nitrilo

10 (XL)

INDUSTRIAL



CE
EN388
4121

- Revestido de nitrilo en palma
- Usado en ambientes con poco aceite

Código	Medida
TSP12101P-M	M
TSP12101P-L	L
TSP12101P-XL	XL
TSP12101P-XXL	XXL

Guantes de latex

10 (XL)

INDUSTRIAL



CE
EN388
1131

- Palma texturizada para mejor agarre
- Para trabajo pesado

Código	Medida
TSP13106-XL	10(XL)

Guantes de latex

10 (XL)

INDUSTRIAL



CE
EN388
2242

- Usado en cargas pesadas y afiladas

Código	Medida
TSP13101	10(XL)

Guantes de latex

10 (XL)

INDUSTRIAL



CE
EN388
4543

- Guantes resistentes a cortes y abrasiones

Código	Medida
TSP1706-XL	10(XL)

Guantes resistentes a corte

XL

INDUSTRIAL



CE
EN388
4542

- Resistentes a corte
- Usado para vidrios, láminas etc.

Código	Medida
TSP1701-XL	XL

Guantes de Poliuretano

XL

INDUSTRIAL



CE
EN388
113XX

12 pares

SUPER SELECT

Código	Medida
TSPUG01	XL

Guantes resistentes a cortes y abrasiones

XL

INDUSTRIAL



CE
EN388
4121X

Nivel de protección de corte 5

• Antiestático

SUPER SELECT

Código	Medida
TSP1702-XL	XL

Guantes de mecánico premium

XL

INDUSTRIAL



- Resistentes a la abrasión extrema

Código	Medida
TSP1806-XL	XL

Guantes para soldador

16"

INDUSTRIAL



16"

- Cocido con Kevlar para evitar que se queme

Código	Medida
TSP15161	16"

Guantes de cuero de vaca

10.5 (XL)

INDUSTRIAL



- Usado por portadores, operadores de mecanizado, trabajos de jardinería etc.

Capa de cuero extra para mayor resistencia

Código	Medida
TSP14101P	10.5

Guantes suaves para soldar

14" (330g)

INDUSTRIAL

NEW



48

- Tejido en Kevlar
- Cuero real grado AB
- Interior terciopelo

Código	Medida
TSP15014	14"

Guantes para soldar 350°

16" (475g)

INDUSTRIAL

NEW



36

- Tejido en Kevlar
- Cuero de vaca
- Alta temperatura

Código	Medida
TSP15216	16"

Guantes para TIG-MIG cuero

16" (200g)

INDUSTRIAL

NEW



96

- Cuero Kevlar
- Cuero premium de cabra ultra suave

Código	Medida
TSP19141	16"

Guantes de nitrilo extendido de seguridad

L

INDUSTRIAL

NEW



240

- Resistente al desgaste (aceite, ácida y alcalina)

Código	Medida
TSP12103	L

Guantes de nitrilo aries para trabajo pesado

XL (60g)

INDUSTRIAL

NEW



Recubierta de nitrilo esmerilado doble

120

- Para trabajo pesado (químicos y objetos punzantes)

Código	Medida
TSPNF01	XL

Guantes de látex domésticos

L (32cm)

INDUSTRIAL

NEW



144

- Fuerza de agarre
- Evita el resbale de objetos

Código	Medida
TSP1632	L

Guantes de PVC para limpieza

L (32cm)

INDUSTRIAL

NEW



Size: L
PVC

144

- Uso para jardinero, limpiador

Código	Medida
TSP1801	L

Guantes de PVC alta calidad para limpiar y lavar platos

L (32cm)

INDUSTRIAL

NEW



SUPER SELECT

144

- Para lavar platos, limpiar artículos diversos

Código	Medida
TSP1802	L

Guantes de PVC de alta calidad

XL

INDUSTRIAL

NEW



SUPER SELECT

72

- Resistente al aceite y ácidos
- Se puede usar en la industria química

Código	Medida
TSP1803	XL

Guantes de nitrilo

L



120 12

- Caja de 100 piezas

Código	Medida
TSP12104L	L

Mangas de cuero para soldador

57x13 cm

INDUSTRIAL

NEW



23.5cm
57cm
14cm

40

- Protege sus brazos de salpicaduras y calor

Código	Medida
TSPWS01	57x13 cm

Delantal de cuero sencillo para soldar

82x51 cm

INDUSTRIAL

NEW



33cm
51cm
82cm

50

- Aislamiento térmico
- Cuero de vaca
- Retardante de llama

Código	Medida
TSPWA03	82x51 cm

Delantal de cuero para soldar

82x51 cm

INDUSTRIAL

NEW

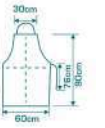

40

- Aislamiento térmico
- Cuero de vaca
- Retardante de llama

Código	Medida
TSPWA01	82x51 cm

Polainas de carnaza para botas de soldador

33x18 cm

INDUSTRIAL

NEW

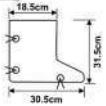

50

- Durable, flexible, resistente al calor y abrasión
- Cuero de vaca

Código	Medida
TSPWL01	33x18 cm

Capucha de cuero para soldador

1.0 - 1.2mm

INDUSTRIAL

NEW



24

- Tafetán de poliéster forrado con hilo de RF cosido

Código	Espesor
TSP20101	1.0 - 1.2mm

Capa y mangas de cuero para soldador

L

INDUSTRIAL

NEW



12

- Hilo de piel vacuno cosido
- Espesor 1.0 - 1.2mm

Código	Medida
TSP20102	L

Chaqueta de soldador resistente a las llamas

L

INDUSTRIAL

NEW



10

- Bolsillos de cuero, botones metálicos, hilo FR cosido
- Espesor 1.0 - 1.2mm

Código	Medida
TSP20103	L



Arnés de seguridad

INDUSTRIAL

NEW



10

- 1 punto de fijación
- 3 puntos de ajuste

Código	Ancho de cinta
THSH502502	45mm

Arnés de seguridad

INDUSTRIAL

NEW



10

- 1 punto de fijación
- 5 puntos de ajuste

Código	Ancho de cinta
THSH502503	45mm

Arnés de seguridad

INDUSTRIAL

NEW



EN 361

10

- 1 punto de fijación
- 5 puntos de ajuste

Código	Ancho de cinta
THSH502507	45mm

Arnés de seguridad

INDUSTRIAL

Ø14mmX1.5m

NEW



10

- 1 punto de fijación
- 4 puntos de ajuste
- Tamaño de la cuerda: 14mm x 1.5m

Código	Ancho de cinta
THSH501503	50mm

Arnés de seguridad

INDUSTRIAL

NEW



10

- 3 punto de fijación
- 5 puntos de ajuste

Código	Ancho de cinta
THSH502505	45mm

Arnés de seguridad

INDUSTRIAL

NEW



10

- 4 punto de fijación
- 4 puntos de ajuste

Código	Ancho de cinta
THSH502506	45mm

Arnés de seguridad

INDUSTRIAL



EN 361

NEW

- 3 punto de fijación
- 4 puntos de ajuste

Código	Ancho de cinta
THSH502508	45mm

10

Arnés de seguridad estilo paracaidista

INDUSTRIAL



Ø14mmX1.8m

NEW

- 1 punto de fijación
- 4 puntos de ajuste
- Tamaño de la cuerda: 14mm x 1.5m

Código	Ancho de cinta
THSH501502	45mm

10

Arnés de seguridad

INDUSTRIAL



NEW

- 1 punto de fijación
- 4 puntos de ajuste

Código	Ancho de cinta
THSH502501	45mm

6

Arnés de seguridad

INDUSTRIAL



- 1 punto de fijación
- 4 puntos de ajuste

Código	Ancho de cinta
THSH501506	50mm

10

Arnés de seguridad

INDUSTRIAL



- 3 punto de fijación
- 4 puntos de ajuste

Código	Ancho de cinta
THSH501806	50mm

10

Mosquetón de acero con cierre S para Arnés

5000lbs/23kN

INDUSTRIAL

NEW

LC:5000lbs/23kN



Código	Medida
THSC301303	60x110mm

100

Cable de posicionamiento tipo cuerda nylon

1.80m

INDUSTRIAL

NEW

Ø14mmX1.8m



Código	Medida
THSL301305	14mmx180m

20

Cable de posicionamiento tipo cuerda nylon

1.80m

INDUSTRIAL

NEW

Ø14mmX1.8m



- Con ganchos de cierre automático y mosquetón en el extremo

Código	Medida
THSL301306	14mmx180m

20

Cintas con amortiguación de impacto para arnes

1.80m

INDUSTRIAL

NEW

30mmX1.8m



- Con ganchos de cierre automático en el extremo

Código	Ancho
THSL301302	30mm

10

Cable de seguridad tipo cuerda nylon

1.80m

INDUSTRIAL

NEW

2Tx5.8m



- Con ganchos de cierre automático en lo extremo

Código	Ancho
THSL301304	14mm

20

Eslinga ojo-ojo

1T (2m)

INDUSTRIAL

NEW



- Eslinga económica y adaptable sin puntos fijos de desgaste

Código	Largo/ancho	Caja
THTWS0102	2mx30mm	20

20

Eslinga ojo-ojo

2T (3m,4m,7m)

INDUSTRIAL

NEW



- Eslinga económica y adaptable sin puntos fijos de desgaste

Código	Largo/ancho	Caja
THTWS0203	3mx30mm	30
THTWS0204	4mx60mm	20
THTWS0207	7mx60mm	12

Eslinga ojo-ojo 3T (3m,6m,10m)

INDUSTRIAL

NEW



3T
Capas gruesas

Código	Largo/ancho	Caja
THTWS0303	3mx30mm	15
THTWS0306	6mx90mm	9
THTWS0310	10mx90mm	6

• Eslinga económica y adaptable sin puntos fijos de desgaste

Eslinga ojo-ojo 4T (4m,6m)

INDUSTRIAL

NEW



4T
Capas gruesas

Código	Largo/ancho	Caja
THTWS0404	4mx120mm	8
THTWS0406	6mx120mm	6

• Eslinga económica y adaptable sin puntos fijos de desgaste

Eslinga ojo-ojo 6T (4m)

INDUSTRIAL

NEW



6T
Capas gruesas

Código	Largo/ancho	Caja
THTWS0604	4mx120mm	5

• Eslinga económica y adaptable sin puntos fijos de desgaste

Correa sujetadora con matraca 5T - 8T (10m)

INDUSTRIAL

NEW



Código	Largo/ancho	Capacidad	Caja
THTRS5104	10mx50mm	5T	10
THTRS8101	10mx75mm	8T	4

Correa para remolque 2T (5.8m)

INDUSTRIAL

NEW



2Tx5.8m

Código	Largo/ancho	Capacidad
THTTS0206	5.8mx50mm	2T

Banda malacate con gancho plano 8T (8m)

INDUSTRIAL

NEW



8Tx8m

75 mm

Código	Largo/ancho	Capacidad
THWS0808	8mx75mm	8T

Sujetador tipo matraca 1.8m, 3m, 4.5m

INDUSTRIAL

NEW



0.8T

25 mm

Código	Largo/ancho	Capacidad	Caja
THTRS08182	1.8mx25mm	0.8 T	50
THTRS08302	3mx25mm	0.8 T	50
THTRS08452	4.5mx25mm	0.8 T	40

Sujetador tipo matraca 6m

INDUSTRIAL

NEW



0.8Tx6m

25 mm

Código	Largo/ancho	Capacidad
THTRS08062	6mx25mm	0.8 T

Sujetador tipo hebilla 3m

INDUSTRIAL

NEW



0.8Tx3m

25 mm

Código	Largo/ancho	Capacidad
THTRS08303	3mx25mm	0.8 T

Juego de 2 sujetadores tipo hebilla 4.5m

INDUSTRIAL

NEW



0.65Tx4.5m

25 mm

Código	Largo/ancho	Capacidad
THTRS065186	4.5mx25mm	0.65 T

Juego de 2 sujetadores y tensores tipo matraca 1.8m

INDUSTRIAL

NEW



0.65Tx1.8m

25 mm

Código	Largo/ancho	Capacidad
THTRS065185	1.8mx25mm	0.65 T

Juego de 2 sujetadores y tensores tipo matraca 4.5m

INDUSTRIAL

NEW



0.65Tx4.5m

25 mm

Código	Largo/ancho	Capacidad
THTRS065455	4.5mx25mm	0.65 T

Juego de 4 sujetadores tipo matraca y hebilla
4.5m **INDUSTRIAL** **NEW**

0.65Tx4.5m 25 mm

Código | **Largo/ancho** | **Capacidad**
THTRS065456 | 4.5mx25mm | 0.65 T

Juego de 4 sujetadores tipo matraca
6m **INDUSTRIAL** **NEW**

0.65Tx6m 25 mm

Código | **Largo/ancho** | **Capacidad**
THTRS065606 | 6mx25mm | 0.65 T

Correa tensora
1.5T, 2T, 3T **INDUSTRIAL**

Ancho

CE
100% PES

Código	Carga	Largo	Ancho
THTRS2061	1.5T	6m	25mm
THTRS2101	2T	10m	35mm
THTRS3101	3T	10m	50mm

Correa tensora
5T **INDUSTRIAL** **NEW**

50 mm

CE
100% PES

Código	Carga	Largo	Ancho
THTRS5101	5T	10m	50mm

Chaleco reflector **INDUSTRIAL**

Cinta altamente reflectiva

Código | **Medida** | **Material**
TSP502 | XL | Polyester tricot

Rodillera **INDUSTRIAL**

215x180mm

PVC

- La carcasa exterior de PVC, resistente a impactos
- Cuerpo de espuma moldeada
- Dos correas elásticas y hebillas flexibles

Código	Medida
THKPT0201	215x180mm

Máscara antipolvo **INDUSTRIAL**

• Protección contra el polvo no tóxico, para operaciones polvorrientas

Código	Material
TSP403	Poliéster

Máscara antipolvo **INDUSTRIAL**

Polipropileno
Filtro de fibra PP P2X2
Poliéster

• Aplicaciones sugeridas para trabajos de pulido, lijado y barrido

FFP2

Código
TSP401

Máscara antipolvo **INDUSTRIAL**

Polipropileno
Filtro de fibra PP P2X2
Poliéster

• Aplicaciones sugeridas para trabajos de pulido, lijado y barrido

FFP2

Código
TSP402

Máscara antipolvo **INDUSTRIAL**

Polipropileno
Filtro de fibra PP P2X2
Carbón activado
Poliéster

• Tres máscaras antipolvo con carbón activado y válvula para mejor respiración

FFP2 EN 149:2001 CE 0121

1 pza

Código
TSP408

Máscara FFP2 con 4 capas **INDUSTRIAL**

Antivirus

• Polypropileno, fibra filtro PP y Poliéster. 92% de eficacia de filtración mínima. Ofrece protección frente a residuos no tóxicos. También frente a elementos fibrogénicos

FFP2

Código	Piezas
TSP412	5 pzas
TSP412 (1 unidad)	1 pza

Respirador **INDUSTRIAL**

✓ Pintura en aerosol
✓ Fábrica de ácido
✓ Alcantarillados
✗ Fábrica de fertilizantes

• Incluye dos cartuchos

Código
THRS02

Repuesto de respirador

INDUSTRIAL



- Orange: Vapores anti-orgánicos y gases con punto de ebullición igual o superior a 65 °C
- Gris: Vapores y gases anti - inorgánicos
- Amarillo: Dióxido de azufre, gases ácidos y otros vapores

200 1

Código	Compatibilidad
THCD02	THRS02

Lentes de seguridad

INDUSTRIAL



- Transparentes



48 12

Código
TSP301

Lentes de seguridad

INDUSTRIAL



- Transparentes
- Cumple con ANSI Z87.1 y CE EN166



60 5

Código
TSP304

Lentes de seguridad

INDUSTRIAL



- Transparentes



NEW

SUPER SELECT

90

Código
TSP342

Lentes de seguridad

INDUSTRIAL



- Para trabajar bajo el sol



48 12

Código	Tono oscuro
TSP305	N8

Lentes de seguridad

INDUSTRIAL



- Transparentes cerrados



64 16

Código
TSP302

Lentes de seguridad

INDUSTRIAL



- Nivel de oscuridad: 9
- Ligero, cómodo de llevar, amplio campo visual



48 4

Código	Tono oscuro
TSP306	N9

Lentes de seguridad

INDUSTRIAL



- Nivel de oscuridad: 10
- Ligero, cómodo de llevar, amplio campo visual



Soldadura

48 4

Código	Tono oscuro
TSP307	N10

Lentes de seguridad

INDUSTRIAL



- Transparentes
- Campo de visión 180°



100

Código
TSP309

Lentes para soldar

INDUSTRIAL



- Cuerpo de PVC flexible



Código
TSP303

Casco de seguridad

INDUSTRIAL

Material 100% ABS



Código	Color	Modelo
TSP601	Azul	Antiguo
TSP2601	Azul	Nuevo
TSP602	Blanco	-

20 20

Casco de seguridad

INDUSTRIAL

Material 100% PP



Código	Color
TSP605	Amarillo

20 20

Casco de seguridad

INDUSTRIAL

Material 100% PE



Código	Color
TSP2605	Naranja
TSP2608	turquesa
TSP2609	Blanco
TSP2610	Azul
TSP2611	Rojo
TSP2612	Amarillo



Careta a prueba de impactos

INDUSTRIAL



Código
TSP610

Careta a prueba de impactos

INDUSTRIAL



Código
TSP631

Máscara de soldador

Material 100% PP



Código	Material
TSP9216	PP



Máscara de soldador

INDUSTRIAL



Código	Area vista	Tono oscuro
TSP9306	92x42mm	variable 9 - 13



Máscara de soldador

INDUSTRIAL



Código	Area vista	Tono oscuro
TSP9309	90x35mm	tono fijo 11



• Oscurecimiento automático

Máscara de soldador

INDUSTRIAL



Código	Area vista	Tono oscuro
TSP9103	100x67mm	variable 9 - 13



• Encendido automático

Tapones de oído

INDUSTRIAL

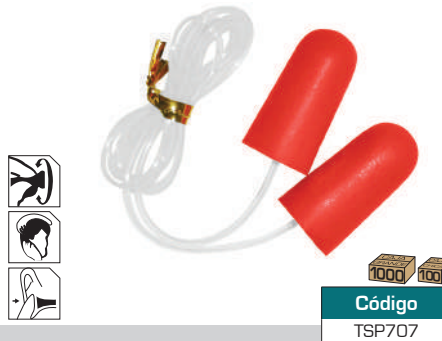

Código
TSP707



Protector de oídos

INDUSTRIAL



Código
TSP701



24dB



ABS

Cinta adhesiva aislante

PVC puro

INDUSTRIAL



Código	Ancho	Longitud	Espesor
THPET1102	18mm	9.15m	0.19mm

Cinta adhesiva aislante

PVC

INDUSTRIAL



Código	Ancho	Longitud	Espesor
THPET1103	18mm	9.15m	0.13mm



Easy

Cinta adhesiva aislante

PVC

INDUSTRIAL



Código	Ancho	Longitud	Espesor
THPET1109	19mm	20m	0.13mm



Easy

NEW

Cinta adhesiva aislante

PVC

INDUSTRIAL

NEW



Código	Ancho	Longitud	Espesor	Color
THPET1010	18mm	20m	0.13mm	Azul
THPET1011	18mm	20m	0.13mm	Amarillo
THPET1012	18mm	20m	0.13mm	Rojo

Cinta adhesiva aislante PVC puro

10 pzas

INDUSTRIAL

NEW



Código	Ancho	Longitud	Espesor
THPET1013	18mm	20m	0.13mm

Batería alcalina

AAA / AA

INDUSTRIAL



Código	Tipo	Capacidad
THAB3A01	AAA (LR03)	1300 mAh
THAB2A01	AA (LR6)	2900 mAh

Batería alcalina

D (LR20) - 1.5V

INDUSTRIAL

NEW



Código	Tipo	Capacidad
THAB1D01	D (LR20)	18000 mAh

Linterna de mano

300 lumen



Código	Batería	Lumens
TWLI35261	Litio recargable	75 - 300

Linterna de mano

3xAAA

INDUSTRIAL

NEW



Código	Batería	Medida
TFL013AAA58	3xAAA	34x126.5

Linterna de mano

27.5x158.3mm

INDUSTRIAL



Código	Batería	Medida
TCFL186503	18650 Li-Ion	27.5x158.3

Lámpara de cabeza

3xAAA

INDUSTRIAL

NEW



Código	Batería	Medida
THL013AAA6	3xAAA	90x45

Lámpara de cabeza

3xAAA

INDUSTRIAL



Código	Batería	Medida
THL013AAA2	3xAAA	90x45

Chaqueta cortavientos

INDUSTRIAL



Código	Medida	Material
TJCTC2282.L	L	Taslan 228
TJCTC2282.XL	XL	Taslan 228
TJCTC2282.XXL	XXL	Taslan 228

Traje impermeable

INDUSTRIAL

Material: PVC+Polyester
Espesor: 0.33 mm
Dos bolsillos con solapa



Código	Medida
THTRS031.M	M
THTRS031.L	L
THTRS031.XL	XL
THTRS031.XXL	XXL
THTRS031.XXXL	XXL

Capote impermeable

INDUSTRIAL



Material: PVC+Polyester
Espesor: 0.33 mm
Longitud: 120 cm
Dos bolsillos con solapa

Código	Medida	Código	Medida
THTRC031.M	M	THTRC031.XXL	XXL
THTRC031.L	L	THTRC031.XXXL	XXXL
THTRC031.XL	XL		

Traje impermeable

INDUSTRIAL

Material: PVC+Polyester
Espesor: 0.33 mm
Dos bolsillos con solapa

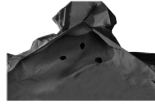

Impermeable, con orificios de ventilación

Código	Medida
THTRS031AB.M	M
THTRS031AB.L	L
THTRS031AB.XL	XL
THTRS031AB.XXL	XXL
THTRS031AB.XXXL	XXL



Material 100% PVC

Botas de PVC/Nitrilo

INDUSTRIAL

Material 100% PVC

CE
EN20347



Suela antideslizante



Altura 37cm
100% resistentes al agua, aceite, ácidos, alcalinos



Código	Talla	Altura
TSP302LAB.39	39	37mm
TSP302LAB.40	40	37mm
TSP302LAB.41	41	37mm
TSP302LAB.42	42	37mm
TSP302LAB.43	43	37mm
TSP302LAB.44	44	37mm
TSP302LAB.45	45	37mm



Botas de caucho

INDUSTRIAL

CE
EN20347



Suela antideslizante



Altura 39cm
100% resistentes al agua, aceite, ácidos, alcalinos



Código	Talla	Altura
TSP302L.39	39	39mm
TSP302L.40	40	39mm
TSP302L.41	41	39mm
TSP302L.42	42	39mm
TSP302L.43	43	39mm
TSP302L.44	44	39mm
TSP302L.45	45	39mm



Botas de seguridad

INDUSTRIAL



Punta de acero

Entresuela de acero

Suela antideslizante



Altura 39cm
100% resistentes al agua, aceite, ácidos, alcalinos



Código	Talla	Altura
TSP302S1P.39	39	39mm
TSP302S1P.40	40	39mm
TSP302S1P.41	41	39mm
TSP302S1P.42	42	39mm
TSP302S1P.43	43	39mm
TSP302S1P.44	44	39mm
TSP302S1P.45	45	39mm
TSP302S1P.46	46	39mm



Botas de seguridad

Altura media

Material 100% PVC



- 100% aprueba de agua
- Resistente al aceite, ácido y a los álcalinos
- Acabado brillante

INDUSTRIAL



Código	Talla	Altura
TSP303L.39	39	20mm
TSP303L.40	40	20mm
TSP303L.41	41	20mm
TSP303L.42	42	20mm
TSP303L.43	43	20mm
TSP303L.44	44	20mm
TSP303L.45	45	20mm
TSP303L.46	46	20mm



Botas de seguridad

Punta de acero

Suela PU de doble densidad



- Capa superior de cuero dividida
- Suela de PU de doble densidad

INDUSTRIAL



Código	Talla	Protección
TSP204SB.39	39	SB: punta de acero
TSP204SB.40	40	SB: punta de acero
TSP204SB.41	41	SB: punta de acero
TSP204SB.42	42	SB: punta de acero
TSP204SB.43	43	SB: punta de acero
TSP204SB.44	44	SB: punta de acero
TSP204SB.45	45	SB: punta de acero
TSP204SB.46	46	SB: punta de acero



Botas de cuero de seguridad

Punta de acero

S3

Entresuela de acero

Suela PU de doble densidad



- Punta de Acero + Entresuela de Acero + Anticlavos + Antiresbalante + Anti vibracion + Dieléctrico. Buena Transpirabilidad.

INDUSTRIAL



Código	Talla	Protección
TSP227S3.36	36	S3: Punta de Acero + Entresuela de Acero + Anticlavos + Antiresbalante + Anti vibracion + Dieléctrico. Buena Transpirabilidad.
TSP227S3.37	37	
TSP227S3.38	38	
TSP227S3.39	39	
TSP227S3.40	40	
TSP227S3.41	41	
TSP227S3.42	42	
TSP227S3.43	43	
TSP227S3.44	44	
TSP227S3.45	45	
TSP227S3.46	46	

S1P



Botas de seguridad

Punta de acero

Suela PU de doble densidad



- Sistema de soporte
- Capa superior de cuero dividida
- Suela de PU de doble densidad

INDUSTRIAL



Código	Talla	Protección
TSP203SB.39	39	SB: punta de acero
TSP203SB.40	40	SB: punta de acero
TSP203SB.41	41	SB: punta de acero
TSP203SB.42	42	SB: punta de acero
TSP203SB.43	43	SB: punta de acero
TSP203SB.44	44	SB: punta de acero
TSP203SB.45	45	SB: punta de acero
TSP203SB.46	46	SB: punta de acero
TSP203SB.47	47	SB: punta de acero



Botas de seguridad

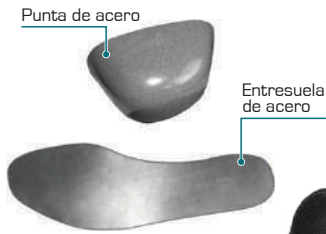

INDUSTRIAL



S1P



Código	Talla	Clase de protección
TSP201S1P.39	39	S1P: SB & entresuela
TSP201S1P.40	40	S1P: SB & entresuela
TSP201S1P.41	41	S1P: SB & entresuela
TSP201S1P.42	42	S1P: SB & entresuela
TSP201S1P.43	43	S1P: SB & entresuela
TSP201S1P.44	44	S1P: SB & entresuela
TSP201S1P.45	45	S1P: SB & entresuela
TSP201S1P.46	46	S1P: SB & entresuela
TSP201S1P.47	47	S1P: SB & entresuela
TSP201S1P.48	48	S1P: SB & entresuela

Botas de seguridad



- Parte superior de cuero de alta calidad
- Suela de poliuretano de doble espesor

INDUSTRIAL



SB



Código	Talla	Clase de protección
TSP209SB.39	39	SB: punta de acero
TSP209SB.40	40	SB: punta de acero
TSP209SB.41	41	SB: punta de acero
TSP209SB.42	42	SB: punta de acero
TSP209SB.43	43	SB: punta de acero
TSP209SB.44	44	SB: punta de acero
TSP209SB.45	45	SB: punta de acero
TSP209SB.46	46	SB: punta de acero

Botas de seguridad



+Aire

Parte superior tipo flyknit para una mejor ventilación y transpirabilidad



- Parte superior tipo Flyknit. Mayor transpirabilidad
- Suela de poliuretano de doble espesor

INDUSTRIAL



SB



Código	Talla	Clase de protección
TSP208SB.39	39	SB: punta de acero
TSP208SB.40	40	SB: punta de acero
TSP208SB.41	41	SB: punta de acero
TSP208SB.42	42	SB: punta de acero
TSP208SB.43	43	SB: punta de acero
TSP208SB.44	44	SB: punta de acero
TSP208SB.45	45	SB: punta de acero
TSP208SB.46	46	SB: punta de acero

Botas de seguridad con aislamiento

6kv



- Voltaje máximo: 6KV
- Parte superior de cuero de alta calidad
- Suela de poliuretano de doble espesor
- Anti-vibración

INDUSTRIAL



SBP



Código	Talla	Clase de protección
TSP207ISSBP.39	39	SBP: p.acero, entresuela
TSP207ISSBP.40	40	SBP: p.acero, entresuela
TSP207ISSBP.41	41	SBP: p.acero, entresuela
TSP207ISSBP.42	42	SBP: p.acero, entresuela
TSP207ISSBP.43	43	SBP: p.acero, entresuela
TSP207ISSBP.44	44	SBP: p.acero, entresuela
TSP207ISSBP.45	45	SBP: p.acero, entresuela
TSP207ISSBP.46	46	SBP: p.acero, entresuela

Cerradura de puerta

INDUSTRIAL



Cilindro Bronce

Cobre

Código	Medida	Llaves	Cilindro
TLK7701	140mm	3 Pzas	Bronce

Picaporte pasador con cerradura

INDUSTRIAL

NEW



Cilindro latón

Cobre

Código	Medida	Llaves	Cilindro
TLKRL852FC	52mm	5 Pzas	Latón

Picaporte pasador con cerradura

INDUSTRIAL

NEW



Cilindro latón

Cobre

Código	Medida	Llaves	Cilindro
TLKRL1043FC	43mm	5 Pzas	Latón

Picaporte pasador con cerradura

INDUSTRIAL

NEW

- Lado derecho
- Cabezal de bloqueo
- Perno: Acero cromado



Cilindro latón

Cobre

Código	Medida	Llaves	Cilindro
TLKRL1349RFC	49mm	2 Pzas	Latón

Picaporte pasador con cerradura

INDUSTRIAL

NEW

- Lado derecho
- Cabezal de bloqueo
- Perno: Acero cromado



Cilindro latón

Cobre

Código	Medida	Llaves	Cilindro
TLKRL1449RFC	49mm	3 Pzas	Latón

Pasador picaporte tipo perno

INDUSTRIAL

NEW



• Acero

Código	Medida	Espesor	C. Grande
THTB115	1-1/2"	1.2/φ6.4mm	600
THTB102	2"	1.2/φ6.4mm	480
THTB125	2-1/2"	1.2/φ6.4mm	480
THTB103	3"	1.2/φ7.4mm	360
THTB104	4"	1.2/φ7.4mm	240

Aldaba portacandado

INDUSTRIAL

NEW

• Acero

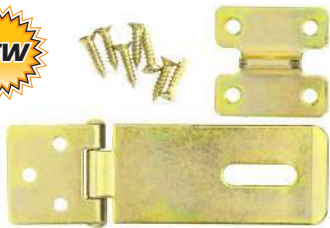

Código	Medida	Espesor	C. Grande
THSS1015	1.5"	20x1.1mm	720
THSS1035	3.5"	38x1.9mm	192
THSS1055	5.5"	38x1.9mm	144

Par de cierre de puerta doble rodillo

INDUSTRIAL

2 pzas

NEW

- Acero Galvanizado
- Incluye sujetadores



Código	Medida	Espesor
TRC2304	1-1/4"	0.6mm

Escuadras de esquina de 90° galvanizadas

INDUSTRIAL

4 pzas

NEW

- Acero Galvanizado
- Incluye sujetadores



Código	Medida	Espesor
TCB2020	20x20mm	1.9mm

Escuadras de esquina de 90° galvanizadas

INDUSTRIAL

4 pzas

NEW

- Acero Galvanizado
- Incluye sujetadores



Código	Medida	Espesor
TCB2050	50x50mm	1.9mm

Candado

INDUSTRIAL

20, 30, 40mm



Cobre

Corrosión nivel 4

Código	Medida	Peso	Llaves	Fuerza	C. Grande	C. chica
TLK32202	20mm	40g	3pzas	/	240	12
TLK32302	30mm	84g	3pzas	3	144	12
TLK32402	40mm	142g	3pzas	5	96	12

Candado

INDUSTRIAL

50, 60, 70mm



Cobre

Corrosión nivel 4

Código	Medida	Peso	Llaves	Fuerza	C. Grande	C. chica
TLK32502	50mm	270g	3pzas	7	48	12
TLK32602	60mm	385g	3pzas	8	36	6
TLK32702	70mm	542g	3pzas	9	24	7

Candado largo

20, 40, 60, 70mm **INDUSTRIAL**

NEW

Cobre

Código	Medida	Peso	Llaves	C.Grande
TLK32202L	20mm	40g	3pzas	72
TLK32402L	40mm	158g	3pzas	72
TLK32602L	60mm	423g	3pzas	36
TLK32702L	70mm	580g	3pzas	24

Candado

60, 70mm **INDUSTRIAL**

Cobre

Corrosión nivel 4

Código	Medida	Peso	Llaves	Fuerza	C. Grande	C. chica
TLK32603	60mm	234g	3pzas	7	48	6
TLK32703	70mm	411g	3pzas	7	36	6

Candado

80, 90mm **INDUSTRIAL**

Cobre

Corrosión nivel 4

Código	Medida	Peso	Llaves	Fuerza	C. Grande	C. chica
TLK32803	80mm	568g	3pzas	8	24	6
TLK32903	90mm	609g	3pzas	9	24	6

Candado combinado

3x20, 3x30 mm **INDUSTRIAL**

NEW

Cobre

Código	Medida	Peso	Dígitos	C.Grande
TBCK37203	3x20mm	47g	3	72
TBCK37303	3x30mm	116g	3	72

Candado combinado

4x40 mm **INDUSTRIAL**

NEW

Cobre

Código	Medida	Peso	Dígitos	C.Grande
TBCK37404	4x40mm	207g	4	72

Candado de hierro

50mm **INDUSTRIAL**

Hierro

3 llaves de hierro

- Cilindro de cerradura de latón
- Con cubierta de goma impermeable

Código	Medida	Peso	Llaves
TLK31501	50mm	289g	3pzas

Juego de 2 candados de hierro

2 pzas **INDUSTRIAL**

38mm **NEW**

Hierro

4 llaves de hierro

- Cilindro de cerradura de latón
- Con cubierta de goma impermeable

Código	Medida	Peso	Llaves
TLK3172382	38mm	146g	4pzas

Candado largo de hierro

32, 38, 63mm **INDUSTRIAL**

NEW

Hierro

Código	Medida	Peso	Llaves	C.Grande
TLK31321L	32mm	100g	3pzas	120
TLK31381L	38mm	168g	3pzas	120
TLK31631L	63mm	540g	3pzas	48

Candado acero antipalanca

40, 50, 60, 70mm **INDUSTRIAL**

NEW

Acero

Código	Medida	Peso	Llaves	C.Grande
TSLK35401	40mm	223g	3pzas	48
TSLK35501	50mm	313g	3pzas	36
TSLK35601	60mm	440g	3pzas	36
TSLK35701	70mm	566g	3pzas	24

Candado laminado

40, 50 mm **INDUSTRIAL**

NEW

Acero

- Carcasa ABS
- Acero laminado níquelado

Código	Medida	Peso	Llaves	C.Grande
TLPK36401	40mm	186g	3pzas	72
TLPK36501	50mm	555g	3pzas	36

Candados laminados

4 pzas **INDUSTRIAL**

NEW

Acero

- Carcasa ABS
- Acero laminado níquelado

Código	Medida	Peso	Llaves	C.Grande
TLPK364004	40mm	186g	3pzas	36
TLPK365004	50mm	555g	3pzas	18

Candado laminado a prueba de agua

50, 65 mm **INDUSTRIAL**

NEW

Hierro

- Resistente a la intemperie
- Cuerpo de hierro laminado

Código	Medida	Peso	Llaves	C.Grande
TBLK38501	50mm	251g	4pzas	36
TBLK38651	65mm	481g	4pzas	36

Cadena de seguridad para bicicleta

15x1200mm

INDUSTRIAL

NEW

- Trenzado recubierto en PVC
- Cable de alta calidad
- Se puede enrollar para almacenamiento



Código	Medida	Llaves	C.Grande
TBK11512	15x1200mm	2pzas	36

Cadena de seguridad para bicicleta

12x1000mm

INDUSTRIAL

NEW

- Trenzado recubierto en PVC
- Cable de alta calidad
- Se puede enrollar para almacenamiento
- Incluye porta candado y dos llaves



Código	Medida	Llaves	C.Grande
TBK11210	12x1000mm	2pzas	36

Cadena de seguridad para bicicleta

10x1200mm

INDUSTRIAL

NEW

- Combinación de 4 dígitos
- Trenzado recubierto en PVC
- Se puede enrollar para almacenamiento
- Incluye porta candado



Código	Medida	Dígitos	C.Grande
TBK21012	10x1200mm	4	36

Caja fuerte de seguridad

7L, 11L, 19L

INDUSTRIAL

NEW

- Registra 3 a 8 dígitos
- Misma calidad que Yale



Código	Medida (mm)	Capacidad	Grosor
TESF1801	180x280x180	7L	3/1.5mm
TESF2001	200x310x200	11L	3/1.5mm
TESF2501	250x350x250	19L	3/1.5mm

Caja fuerte de seguridad

27L, 52L

INDUSTRIAL

NEW

- Registra 3 a 8 dígitos
- Misma calidad que Yale



Código	Medida (mm)	Capacidad	Grosor
TESF3501	200x430x350	27L	3/1.5mm
TESF5001	500x350x330	52L	3/1.5mm

Bombillo LED

9W

INDUSTRIAL

Tecnología SMD



Código	Potencia	Base	Temp	Color luz
UTLPAC091	9W	E27	6500K	Blanca

Interruptor

1 vía

INDUSTRIAL



• 16A - 250V



Código	Medida	M. instalación
THESSH18111	118x80mm	84mm

Interruptor doble

1 vía

INDUSTRIAL



• 16A - 250V



Código	Medida	M. instalación
THESSH18121	118x80mm	84mm

Interruptor triple

1 vía

INDUSTRIAL



• 16A - 250V



Código	Medida	M. instalación
THESSH18131	118x80mm	84mm

Interruptor

1 vía

INDUSTRIAL



• 45A - 250V



Código	Medida	M. instalación
THESSH18311	118x80mm	84mm

Tomacorriente

16A

INDUSTRIAL



• 16A - 250V



Código	Medida	M. instalación
THEST181101	118x80mm	84mm

Tomacorriente / Interruptor

16A

INDUSTRIAL



• 16A - 250V



Código	Medida	M. instalación
THEST181111	118x80mm	84mm

Tomacorriente con conexión USB

16A

INDUSTRIAL



- 2 conexiones USB
- 16A - 250V

100

Código	Medida	M. instalación
THESST181101US	118x80mm	84mm

Tomacorriente americano

16A

INDUSTRIAL

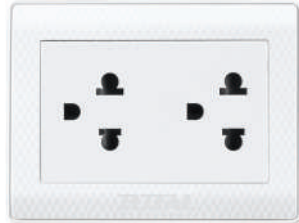

- 16A - 250V

100

Código	Medida	M. instalación
THESST183201	118x80mm	84mm

Tomacorriente doble / Interruptor

16A

INDUSTRIAL



- Tomacorriente tipo americano
- 16A - 250V

100

Código	Medida	M. instalación
THESST184211	118x80mm	84mm

Tomacorriente con conexión USB

16A

INDUSTRIAL



- 2 conexiones USB
- Tomacorriente tipo americano
- 16A - 250V

100

Código	Medida	M. instalación
THESST184101US	118x80mm	84mm

Regulador de abanico / Interruptor

16A

INDUSTRIAL



- 16A - 250V
- 250W 220V

100

Código	Medida	M. instalación
THESFC1802502	118x80mm	84mm

Interruptor

1 vía

INDUSTRIAL



- 16A - 250V

120

Código	Medida	M. instalación
THESHD1101	86x86mm	60mm

Interruptor doble

1 vía

INDUSTRIAL



- 16A - 250V

120

Código	Medida	M. instalación
THESHD2101	86x86mm	60mm

Interruptor triple

1 vía

INDUSTRIAL



- 16A - 250V

120

Código	Medida	M. instalación
THESHD3101	86x86mm	60mm

Interruptor cuádruple

1 vía

INDUSTRIAL



- 16A - 250V

120

Código	Medida	M. instalación
THESHD4101	86x86mm	60mm

Interruptor

1 vía

INDUSTRIAL



- 45A - 250V

120

Código	Medida	M. instalación
THESHD1452	86x86mm	60mm

Interruptor

2 vías

INDUSTRIAL



- 16A - 250V

120

Código	Medida	M. instalación
THESHD1103	86x86mm	60mm

Interruptor

2 vías

INDUSTRIAL



- 16A - 250V

120

Código	Medida	M. instalación
THESHD2103	86x86mm	60mm

Interruptor para timbre

16A

INDUSTRIAL



• 16A - 250V

120

Código	Medida	M. instalación
THESSH11161	86x86mm	60mm

Tapa para cable LAN

INDUSTRIAL



• Para computadoras

120

Código	Medida	M. instalación
THESST301C0	86x86mm	60mm

Tapa para cable coaxial

INDUSTRIAL



• Para cable TV

120

Código	Medida	M. instalación
THESST401TV	86x86mm	60mm

Tomacorriente universal / interruptor / USB

16A

INDUSTRIAL



• 2 conexiones USB • Tomacorriente tipo americano

• 16A - 250V

120

Código	Medida	M. instalación
THESST1116AUS	86x86mm	60mm

Regulador de velocidad para abanico

16A

INDUSTRIAL



• 1000W 220V

120

Código	Medida	M. instalación
THESFC10001	86x86mm	60mm

Tapa para cable coaxial y teléfono

INDUSTRIAL



• Para cable TV y teléfono

120

Código	Medida	M. instalación
THESST502TT	86x86mm	60mm

Tapa de interruptor modular doble

118x80mm

INDUSTRIAL



Código

Medida

THESSH1802

118x80mm

Tapa de interruptor modular triple

118x80mm

INDUSTRIAL

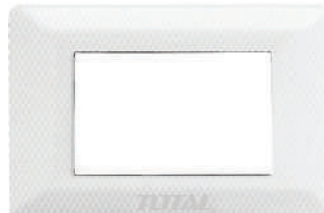

Código

Medida

THESSH1803

118x80mm

Tapa de instalación para tapas de interruptor

118x80mm

INDUSTRIAL



Código

Medida

THESSH1805

118x80mm

Tapa ciega para interruptor

INDUSTRIAL



Código

THESSH1821

Interruptor decorativo modular

16A

INDUSTRIAL



• 16A - 250V

Código

Medida

THESSH1811

118x80mm

Toma corriente sencillo

16A

INDUSTRIAL



• 16A - 250V

Código

Medida

THESST1831

24x45mm

Tornillos de pared

INDUSTRIAL



Código	Medida	Cantidad
WJDS3502511	ST3.5x25mm	250 Pzas
WJDS3503211	ST3.5x32mm	200 Pzas
WJDS3503811	ST3.5x38mm	150 Pzas

Tornillos de pared

INDUSTRIAL



Código	Medida	Cantidad
WJDS4205111	ST4.2x51mm	120 Pzas
WJDS4206311	ST4.2x63mm	100 Pzas

Tornillos de pared

INDUSTRIAL

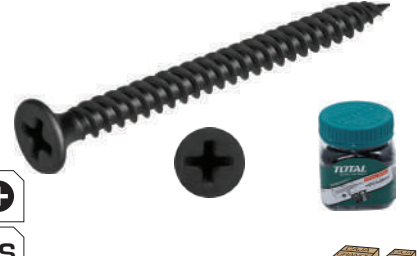

Código	Medida	Cantidad
WJDS3502521	ST3.5x25mm	250 Pzas
WJDS3503221	ST3.5x32mm	200 Pzas

Tornillos de pared

INDUSTRIAL



Código	Medida	Cantidad
WJDS3503821	ST3.5x38mm	150 Pzas
WJDS4205121	ST4.2x51mm	120 Pzas
WJDS4206321	ST4.2x63mm	100 Pzas

Tornillos para aglomerado

INDUSTRIAL



Código	Medida	Cantidad
WJBS3502511	ST3.5x25mm	250 Pzas
WJBS4004011	ST4.0x40mm	150 Pzas
WJBS5005011	ST5.0x50mm	100 Pzas
WJBS5008011	ST5.0x80mm	80 Pzas
WJBS5010011	ST5.0x100mm	60 Pzas

Tornillos penetrante

INDUSTRIAL



Código	Medida	Cantidad
WJPS3501911	ST3.5x19mm	250 Pzas

Tornillos penetrante

INDUSTRIAL



Código	Medida	Cantidad
WJPS4202511	ST4.2x25mm	180 Pzas

Tornillos penetrante

INDUSTRIAL



Código	Medida	Cantidad
WJPS4803811	ST4.8x38mm	100 Pzas

Tornillos penetrante

INDUSTRIAL



Código	Medida	Cantidad
WJPS4201921	ST4.2x19mm	200 Pzas
WJPS4202521	ST4.2x25mm	150 Pzas

Tornillo punta de broca

INDUSTRIAL



Código	Medida	Cantidad
WJSS4202511	ST4.2x25mm	150 Pzas
WJSS4203211	ST4.2x32mm	120 Pzas

Tornillo punta de broca

INDUSTRIAL



Código	Medida	Cantidad
WJSS6302521	ST6.3x25mm	50 Pzas

• Con arandela de goma

Taco de plástico

INDUSTRIAL



Código	Medida	Cantidad
WJSP0804011	8x40mm	80 Pzas
WJSP1005011	10x50mm	40 Pzas

Tornillos para gypsum

INDUSTRIAL

NEW

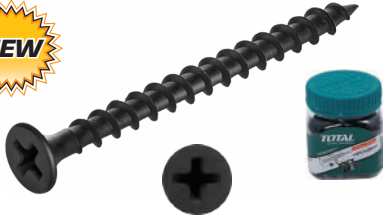

Código	Medida	Rosca	Cantidad
THWDS611	#6X1"	Gruesa	1000 Pzas
THWDS612	#6X1"	Fina	1000 Pzas
THWDS613	#6X1"	Gruesa	100 Pzas
THWDS614	#6X1"	Fina	100 Pzas

Tornillos para gypsum

INDUSTRIAL

NEW

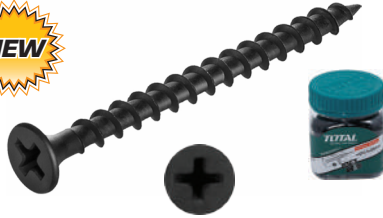

Código	Medida	Rosca	Cantidad
THWDS61141	#6X1-1/4"	Gruesa	650 Pzas
THWDS61142	#6X1-1/4"	Fina	650 Pzas
THWDS61143	#6X1-1/4"	Gruesa	100 Pzas
THWDS61144	#6X1-1/4"	Fina	100 Pzas

Tornillos para gypsum

INDUSTRIAL

NEW



Código	Medida	Rosca	Cantidad
THWDS61581	#6X1-5/8"	Gruesa	400 Pzas
THWDS61582	#6X1-5/8"	Fina	400 Pzas
THWDS61583	#6X1-5/8"	Gruesa	100 Pzas
THWDS61584	#6X1-5/8"	Fina	100 Pzas

Tornillos para gypsum

INDUSTRIAL

NEW



Código	Medida	Rosca	Cantidad
THWDS621	#6X2"	Gruesa	300 Pzas
THWDS622	#6X2"	Fina	300 Pzas
THWDS623	#6X2"	Gruesa	100 Pzas
THWDS624	#6X2"	Fina	100 Pzas

Tornillos para gypsum

INDUSTRIAL

NEW



Código	Medida	Rosca	Cantidad
THWDS101121	#10X1-1/2"	Gruesa	300 Pzas
THWDS101122	#10X1-1/2"	Fina	300 Pzas
THWDS101123	#10X1-1/2"	Gruesa	100 Pzas
THWDS101124	#10X1-1/2"	Fina	100 Pzas

Tornillos para gypsum

INDUSTRIAL

NEW

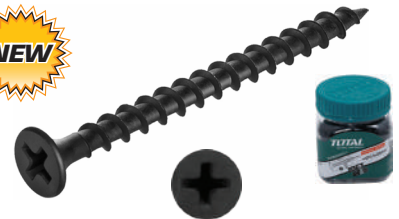

Código	Medida	Rosca	Cantidad
THWDS1021	#10X2"	Gruesa	200 Pzas
THWDS1022	#10X2"	Fina	200 Pzas
THWDS1023	#10X2"	Gruesa	100 Pzas
THWDS1024	#10X2"	Fina	100 Pzas

Tornillo autoperforante punta de broca

INDUSTRIAL

NEW



Código	Medida	Cantidad
THWTD8121	#8X1/2"	800 Pzas
THWTD8341	#8X3/4"	650 Pzas
THWTD811	#8X1"	450 Pzas
THWTD81141	#8X1-1/4"	320 Pzas

Tornillo para techo hexagonal con arandela

INDUSTRIAL

NEW



Código	Medida	Cantidad
THWHD1221	#12X2"	230 Pzas
THWHD122121	#12X2-1/2"	200 Pzas
THWHD14341	#14X3/4"	400 Pzas
THWHD1411	#14x1"	300 Pzas

Tornillo para techo hexagonal con arandela

INDUSTRIAL

NEW



Código	Medida	Cantidad
THWHD141121	#14X1-1/2"	250 Pzas
THWHD1421	#14X2"	180 Pzas
THWHD142121	#14X2-1/2"	150 Pzas
THWHD1431	#14x3"	100 Pzas
THWHD1441	#14x4"	80 Pzas

Taco Anclaje Drop-in 1/4"x1"

INDUSTRIAL

NEW



Código	Medida	Cantidad
THWDA1411	1/4X1"	50 Pzas
THWDA5161141	5/16X1-1/4"	50 Pzas
THWDA381341	3/8X1-3/4"	50 Pzas
THWDA1221	1/2X2"	50 Pzas
THWDA582121	5/8X2-1/2"	50 Pzas

Taco galvanizado de cuña

INDUSTRIAL

NEW



Código	Medida	Cantidad
THWWA141341	1/4x1-3/4"	350 Pzas
THWWA142141	1/4X2-1/4"	300 Pzas
THWWA51621	5/16X2"	180 Pzas
THWWA382121	3/8x2-1/4"	100 Pzas

Taco galvanizado de cuña

INDUSTRIAL

NEW



Código	Medida	Cantidad
THWWA3831	3/8X3"	80 Pzas
THWWA212341	1/2X2-3/4"	70 Pzas
THWWA213341	1/2X3-3/4"	50 Pzas
THWWA2151	1/2X5"	40 Pzas

Taco con camisa

INDUSTRIAL



Código	Medida	Cantidad	Resiste
WJSA0655611	6.5x56mm	30 Pzas	600kg

Taco de cuña

INDUSTRIAL



Código	Medida	Cantidad	Resiste
WJWA0605511	M6x55mm	30 Pzas	900kg
WJWA0808011	M8x80mm	15 Pzas	1300kg

Taco heavy duty con carcasa

INDUSTRIAL



Código	Medida	Cantidad	Resiste
WJHA0605511	M6x55mm	25 Pzas	1000kg
WJHA0806511	M8x65mm	15 Pzas	1200kg

Taco de 4Pzas heavy duty con carcasa

INDUSTRIAL



Código	Medida	Carcasa	Cantidad
WJHA0606021	M6x60mm	10x40mm	24 Pzas
WJHA0807521	M8x70mm	14x50mm	12 Pzas

Taco de gancho 4Pzas heavy duty

INDUSTRIAL



Código	Medida	Carcasa	Cantidad
WJHA0607531	M6x75mm	10x40mm	16 Pzas
WJHA0809531	M8x95mm	14x50mm	8 Pzas

Remache

INDUSTRIAL



Código	Medida	Cantidad	Adecuado
WJRT3200811	3.2x8mm	300 Pzas	TOTAL
WJRT3201011	3.2x10mm	300 Pzas	THT32105
WJRT4001011	4.0x10mm	200 Pzas	THT32171

Remache

INDUSTRIAL



Código	Medida	Cantidad	Adecuad
WJRT4001211	4.0x12mm	180 Pzas	TOTAL
WJRT4801211	4.8x12mm	100 Pzas	THT32105
WJRT4801611	4.8x16mm	100 Pzas	THT32171

Tornillo penetrante

INDUSTRIAL



Código	Medida	Cantidad
WJPS4202521	ST4.2x25mm	150 Pzas
WJPS4204122	ST4.2x41mm	30 Pzas

Tornillo de máquina

INDUSTRIAL



Código	Medida	Cantidad
WJMS0502512	M5x25mm	40 Pzas

Tornillo de máquina

INDUSTRIAL



Código	Medida	Cantidad
WJMS0504012	M5x40mm	30 Pzas
WJMS0602512	M6x25mm	30 Pzas
WJMS0605012	M6x50mm	20 Pzas

Tornillo con final de gancho

INDUSTRIAL



Código	Medida	Cantidad
WJHB0812	M8	5 Pzas

Juego de tornillo y taco

INDUSTRIAL

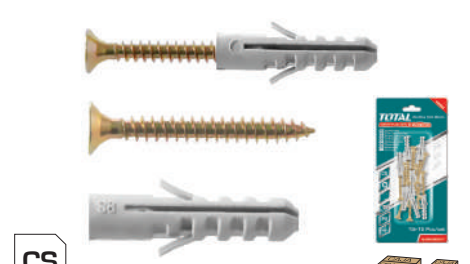

Código	Medida	Taco	Cantidad
WJSPK4504512	ST4.0x40mm	6x30mm	15 Pzas
WJSPK5005512	ST5.0x50mm	8x40mm	10 Pzas

Juego de tornillo y taco

INDUSTRIAL



CS

160 20

Código	Medida	Taco	Cantidad
WJSPK7006512	ST6.5x65mm	10x50mm	5 Pzas

Juego de tornillo con gancho y taco

INDUSTRIAL



CS

160 20

Código	Medida	Taco	Cantidad
WJSPK5012	5mm	8x40mm	6 Pzas

Juego de tornillo con aro y taco

INDUSTRIAL



CS

160 20

Código	Medida	Taco	Cantidad
WJSPK5022	5mm	8x40mm	6 Pzas

Juego de tornillo en L y taco

INDUSTRIAL



CS

160 20

Código	Medida	Taco	Cantidad
WJSPK5032	5mm	8x40mm	6 Pzas

Tornillo con taco de pared hueco

INDUSTRIAL



+

CS

+

100 20

Código	Medida	Cantidad
WJHW4003811	4x38mm	15 Pzas

Juego de tornillo y taco

INDUSTRIAL



CS

160 20

Código	Medida	Taco	Cantidad
WJNAK3505012	ST3.5x50mm	6x40mm	20 Pzas
WJNAK3507012	ST3.5x70mm	6x60mm	15 Pzas
WJNAK5007012	ST5.0x70mm	8x60mm	10 Pzas
WJNAK5009012	ST5.0x90mm	8x80mm	10 Pzas



Exhibidor TOTAL



Código

ZZ-TotalPMST02

Bandeja para exhibidor con brazos



• Bandeja incluye dos brazos

Código

ZZ-TotalPMST02B

Soporte para etiqueta



• Se venden por unidad

Código

ZZ-BAMLABELHOLDER

Ganchos para exhibidor



• Se venden por unidad

Código

ZZ-TotalPMHK03-T-05

Medida

5cm

ZZ-TotalPMHK03-T-10

10cm

Ganchos para exhibidor



• Se venden por unidad

Código

ZZ-GANCHOSTAGHOLD

Medida

30cm

Conviértase en
nuestro distribuidor



Banderola



Código

ZZ-TotalTPMGF03

Catálogo TOTAL



Código

ZZ-CAT/TOTAL

Barrera para exhibidor



• 891x115mm

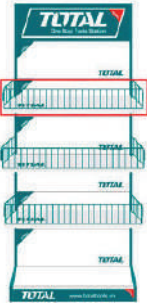

Código

PMST02F

Pañuelos



Código

ZZ-TotalTPMTB01

Bolígrafo de plástico



Código

TPMPEN01

Gorra



Código

ZZ-TotalPMCA04

Tolda 3x3mt



Código

TPMTE01

Calendario



Código

ZZ-TOTALPMDC02

T-Shirt



Código

ZZ-totalPMTS10.M

Medidas

M

ZZ-totalPMTS10.L

L

ZZ-totalPMTS10.XL

XL

Agenda



Código

ZZ-totalPMNB02

TOTAL

Carbone One-Stop Tools Station

TOTAL

TOTAL

Carbone One-Stop Tools Station

Tecnoples SAS.
Carrera 30 # 5B 21
Bogota - Colombia.
Tel: (601) 722 35 08 / ventas@tecnoples.com
www.tecnoples.com.co



TECNO PLES

MÁS QUE UN PROVEEDOR, SU MEJOR ALIADO

